



Copyright ©  
TEM AG  
Triststrasse 8  
CH-7007 Chur

Phone +41 81 254 25 11  
Fax: +41 81 254 25 39  
www.tem.ch  
www.mytem-smarthome.com

**Note**            These documents are property of the company TEM AG and are protected by copyright. Technical descriptions can be changed without prior notice. Possible misprints or changes of any kind occurring in the meantime do not entitle to claims. Reprinting or other duplications, even in extracts, are not allowed without our prior explicit consent.

With myTEM Installation Manual, customized installations for myTEM Smart Home products can be created or adapted quickly and easily. Please read these terms of use carefully.

You may download myTEM installation manual on a hard disk or other storage medium within the scope of the intended use. You may not make and/or distribute a copy of myTEM installation manual for commercial distribution without our approval.

TEM AG accepts no warranty or liability for any damages, consequential damages, including lost profits and lost savings, or for failures that may occur through the use of the myTEM installation manual. You renounce any claims against TEM AG that could result from these procedures.

As far as the liability of TEM AG is excluded, this also applies to partners of TEM AG as well as its affiliated companies, as well as to the personal liability of its employees, representatives and auxiliary persons.

# Table of contents

<b>1</b>	<b>INTRODUCTION.....</b>	<b>6</b>
<b>2</b>	<b>GENERAL INSTALLATION RULES.....</b>	<b>6</b>
2.1	Warnings and Safety instructions.....	6
2.2	Installation.....	6
2.3	Safety instructions.....	7
2.4	Control Panel assembly.....	7
2.5	Flash and Overvoltage protection.....	7
2.6	Use in Explosion-proof systems.....	8
2.7	Construction Products Regulation (CPR).....	8
<b>3</b>	<b>NETWORK TOPOLOGY AND CABLE SELECTION.....</b>	<b>8</b>
3.1	myTEM network topology.....	8
3.2	CAN Cable.....	9
3.3	Free Topology Cable.....	10
<b>4</b>	<b>RANGE OF PRODUCTS.....</b>	<b>10</b>
4.1	myTEM Smart Home System with Smart Server.....	10
4.2	myTEM Smart Home System in Free Topology.....	13
4.3	myTEM Smart Home System with Radio Server.....	16
<b>5</b>	<b>SUPPLY VOLTAGE.....</b>	<b>22</b>
5.1	Overview.....	22
5.2	24V Power supplies.....	22
5.2.1	Installation.....	23
5.2.2	Power Assignment supply cable.....	23
5.3	Power consumption.....	23
5.4	Rule of thumb for designing the Free Topology Network.....	24
5.5	Example of power consumption calculation.....	24
5.6	Power supply selection.....	25
5.7	Line losses (Conduction losses).....	26

<b>6</b>	<b>MYTEM WIRING RULES.....</b>	<b>29</b>
6.1	CAN in Bus-Topology .....	29
6.2	Free Topology network .....	31
<b>7</b>	<b>DEVICE SPECIFIC WIRING NOTES.....</b>	<b>33</b>
7.1	FT DIN SIX wiring notes .....	33
7.2	FT RGBW Modul wiring notes.....	33
7.3	FT Switch Dimmer wiring notes.....	34
7.4	7.4 FT Switch Dual wiring notes.....	34
7.5	FT Base Modul wiring notes .....	34
7.6	Smart Server wiring notes .....	34
7.7	IO Modul wiring notes.....	35
7.8	IO Modul Small wiring notes .....	35
7.9	Relais Modul wiring notes .....	35
7.10	Dimmer Modul wiring notes .....	36
7.11	DALI Modul wiring notes .....	36
7.12	Radio Base Modul wiring notes .....	36
7.13	Radio RGBW Modul wiring notes .....	37
7.14	Radio IO Modul wiring notes.....	37
7.15	Radio IO Modul Floor wiring notes.....	37
7.16	Radio Switch Dual wiring notes .....	38
7.17	Radio Switch Dual Plus wiring notes.....	38
7.18	Radio Switch Shutter Plus wiring notes .....	39
7.19	Radio Switch Dimmer wiring notes .....	39
<b>8</b>	<b>Z-WAVE WIRELESS NETWORK.....</b>	<b>40</b>
8.1	Installation .....	40
8.2	Network connection.....	40
<b>9</b>	<b>LIGHTNING AND OVERVOLTAGE PROTECTION .....</b>	<b>41</b>
9.1	Earthing and potential compensation .....	41

**9.2 Avoid overvoltages.....41**

**10 CONTACT..... 41**

## 1 Introduction

This installation manual is mainly intended for electrical planners and electricians. It describes the assembly and installation of the devices supported by myTEM. It contains many tips, which allow to use myTEM devices more flexible and extensively or to perform the installation efficiently.

This installation manual gives an overview of the installation rules for the following system areas:

- myTEM Smart Home with Single Server (Smart Server, Radio Server)
- myTEM Smart Home with Free Topology

Devices from all system areas can be combined in a single site.

We use myTEM product names throughout this manual. Thus an input module is called "IO Modul".

## 2 General Installation rules

The following rules apply equally to all systems and products.

Installation instructions are included with each product. Please read it completely before installing a device. These specific installation instructions for each device must be observed.

### 2.1 Warnings and Safety instructions

#### **WARNING!**

This term denotes a hazard with a risk that, if not avoided, may result in death or serious injury. Only specially trained persons may carry out work on the devices.

#### **NOTE!**

This term warns of possible damage to property.

### 2.2 Installation

- **WARNING!** Depending on national safety standards, only authorised and/or trained technicians may be permitted to carry out electrical installations on the voltage network. Please inform yourself about the legal situation before installation.
- **WARNING!** Different voltages (e.g. 24 VDC, 230 VAC L1 or 230 VAC L2) may only be connected to the digital outputs (relays) if one output remains FREE in between.

#### **Please install the device according to the steps below:**

- **WARNING!** Make sure that the unit are disconnected from the power supply or that the units in the control panel are disconnected from the power supply.
- **WARNING!** Connect the device according to the wiring diagram of the myTEM ProgTool or the terminal assignment according to the data sheet. Incorrect wiring can result in injury or death or damage to the device.
- **NOTE!** The unit may only be operated with stabilised power supplies (24 VDC). Connection to higher voltages will damage the unit.
- **NOTE!** After configuration, the myTEM Smart Server can be used without connection to the Internet. However, it is recommended to establish a permanent connection between the myTEM Smart Server and an external router / WLAN router using a LAN cable.
- **NOTE!** The enclosed terminating resistor from 120Ω must be connected to the last unit via the terminals of the CAN Bus. A Free Topology installation does not require any termination resistors.
- **WARNING!** After connecting the system to power you may use hand-overwrite DIP-switches to check the correctness of your wiring. Pay attention to your own safety while the devices are powered up.

## 2.3 Safety instructions

- Operate these devices only as described in the operating manual.
- Do not operate the units if they are clearly damaged.
- myTEM devices may not be converted, modified or opened.
- myTEM devices are designed for the use in buildings in a dry, dust-free location.
- myTEM devices which are designed to be installed in a control cabinet must not be openly accessible after installation.
- Installation and assembly of electrical devices may only be carried out by qualified electricians who know and comply with the applicable regulations and standards.
- Analogue inputs/outputs, digital inputs, CAN Bus and device power supply must comply with the ELV requirements. Do not connect ELV and mains voltage together. (ELV = extra-low voltage). With the exception of units where digital inputs have to use the very same potential as the supply voltage of the myTEM device itself. This applies for the following devices: Radio Switch Dual, Radio Switch Dual Plus, Radio Switch Shutter Plus, and Radio Switch Dimmer.
- If several motors are to be connected in parallel at one output, it is important to observe the manufacturer's instructions and use isolating relays if necessary. Otherwise the device can be damaged.  
Note! A measurement of current is not possible, when isolating relays are used.
- Only use blind motors with mechanical or electronic end switches. End switches must be checked for correct adjustment. Otherwise the device can be damaged.
- Do not connect three-phase motors. Otherwise the unit may be damaged.

## 2.4 Control Panel assembly

It goes without saying that all relevant regulations must be observed when building a control panel. In addition, the following aspect for an EMC-compliant construction of a control panel should be observed:

- It must be ensured that the units require some air (at least 2 cm) at the top and bottom of the switch cabinet to facilitate later replacement.
- With the wireless modules Radio RGBD, Radio Base, Radio IO-Modul or Radio IO-Modul Floor it is possible that the control panel may interfere too much with the radio signal and no connection is established. In this case use the external antenna myTEM MTANT-100-WL.
- An EMC-compliant mounting plate must neither be painted nor anodised.
- Earthing rails must be connected to the mounting plate with low resistance.
- Cables of different performance groups must be laid separately.
- Partition walls must be contacted all around.
- Cables must be kept as short as possible.
- If crossing between disturbing and sensitive lines cannot be avoided, they should overlap at right angles.
- All cables must be earthed at the control panel in- and outlets. This earthing should be carried out over as large an area as possible (earthing clamps or earth gland/ do not apply "pig tails"). Cables between control panels may only be connected to earth on one side (no potential equalisation between control panels via our Bus cable!)
- If filters are installed, make sure they are connected correctly.
- When installing fluorescent tubes, it must be taken into account that they are often a source of interference.

## 2.5 Flash and Overvoltage protection

In order to prevent electrical equipment, such as sensors, from forming ignition sources in explosive atmospheres, current and voltage values in the corresponding circuit are limited to permissible maximum values. This is done by means of so-called safety barriers. Clarify with the company TEM AG which barriers are to be provided in the specific application. The myTEM devices themselves must not be operated in rooms where there is a risk of explosion.

## 2.6 Use in Explosion-proof systems

An essential part of the Construction Products Regulation (CPR) and its application in relation to cables relates to fire protection. All new cables permanently installed in buildings must comply with the new regulation. If a fire breaks out inside a building, there are often only a few minutes left to safely leave the burning building. In order not to endanger human lives and to enable the emergency service to work in the event of a fire, the spread of flames must be inhibited and the formation of smoke and toxic (corrosive) gases must be reduced as far as possible. To achieve this, electrical cables and wires are classified according to their fire behaviour and must be used accordingly. Cable manufacturers indicate the CE mark and the fire performance class on the product label.

What classes of cables are required for specific applications (each country must define which cables are recommended for each type of building and special areas within a building- e.g. escape routes) can be found in national and regional regulations.

## 2.7 Construction Products Regulation (CPR)

A main part of the Construction products Regulation (EU No. 305/2011) with regard to cable is concerning preventive fire protection. All new cables laid permanently in a building have to meet these regulations.

When a fire breaks out in a building, often only a few minutes remain to leave the burning building safely. To not endanger person's life and to enable the work of emergency services, flame spread has to be inhibited and the formation of smoke and toxic (corrosive) gases has to be reduced as much as possible. To achieve these objectives, all cables and wires are classified and have to be used accordingly. Cable manufacturer mark their cables with a CE approval and mention the fire behaviour class on the product label.

National and regional regulations define which classes of cables have to be used for specific applications. Types of buildings and special zones within a building (such as escape routes) are described in lists.

# 3 Network topology and cable selection

## 3.1 myTEM network topology

The myTEM system combines advantages of wired and wireless installations. Both technologies may be mixed in a single site. Our wide range of products fits for each application.

We provide two technologies for wired installations. These technologies are different in baudrate and networking topology. Again both technologies may be mixed in a single site and allow the integration of Z-Wave wireless devices by use of a Radio Server or a Radio Base Modul.

Baudrate	Length of cable	Termination	Bit time	myTEM	Example of data cable	CPR DoP
10 kBit/s	500 m	No termination	100 µs	FreeTopology	VOKA BUS EIB	EV 02-17/14
250 kBit/s	250 m	Termination at both ends	4 µs	myTEM CAN	VOKA BUS CAN	FV 01-20/01

Bit time is the maximum signal run time which limits the extension of the network.

The drawing below explains the different networking technologies used by the myTEM system.



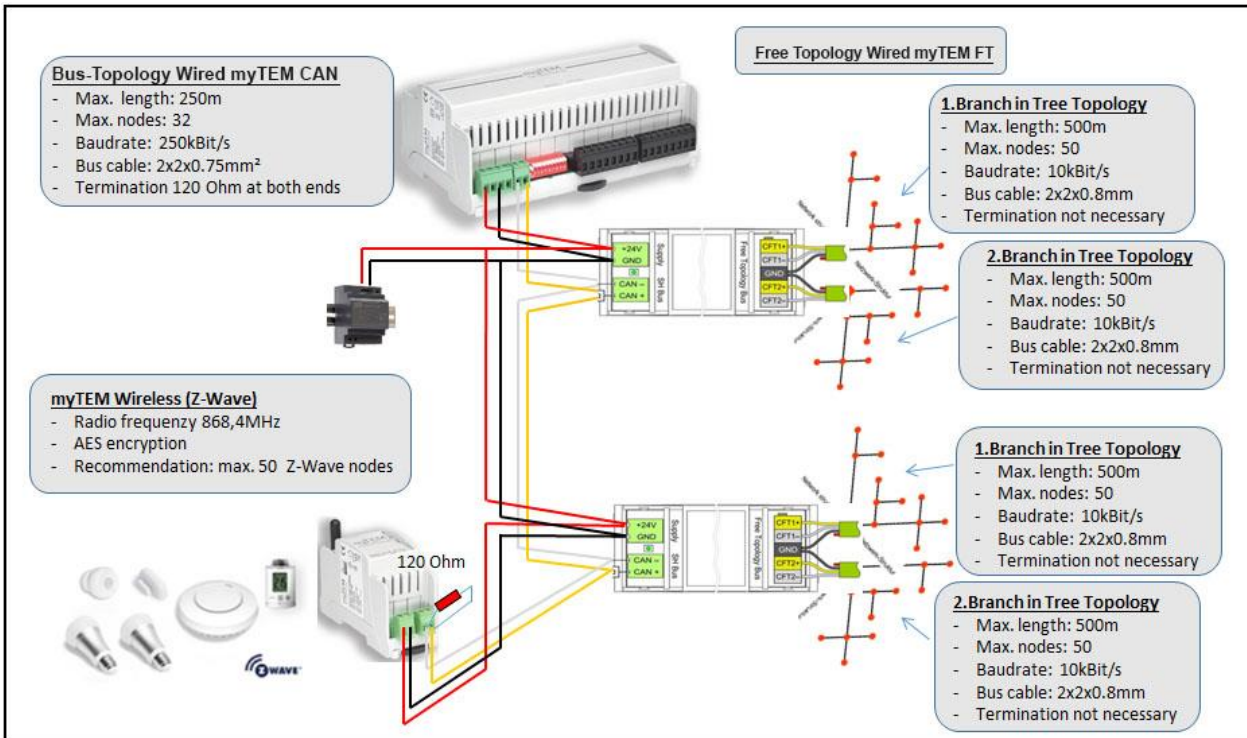

myTEM Smart Home may be called a hybrid system for building automation as it merges components that communicate wired and wireless.

Technology	Standard	Central Processing Unit, Gateway
Wired	myTEM CAN	Smart Server, Radio Server
	myTEM Free Topology	FT Base Modul
Wireless	Z-Wave	Radio Server, Radio Base Modul

### 3.2 CAN Cable

The baudrate of the CAN-Bus is set to 250 kBit/s. Thus the maximum cable length is limited to 250m. Cable losses (thickness, quality of cable) may reduce the maximum length. The only topology allowed is straight bus topology (Daisy-chain). The CAN-Bus must be terminated at both ends. A smart server needs to be placed at one end of the bus since a 120 Ohm resistor is already installed across the CAN terminals.

To achieve a high quality of communication at the maximum length (250m) and the maximum amount of nodes (32), we advise to use a designated CAN-cable of adequate cross section and a nominal impedance of 120 Ohms.

#### Feasible cable for the myTEM CAN-Bus



VOKA CAN Bus 2x2x0,75 mm<sup>2</sup> (cross section)

**Cables have to be selected according to applicable rules in terms of flammability and dielectric strength.**

Standard cable	Pair No.	Durchmesser	Querschnitt	AWG	Widerstand Schleife	EN 13501-6 Klasse
VOKA CAN Bus	2 x 2	0,97 mm	0,75 mm <sup>2</sup>	19	52 Ω / km	Fca

When the bus cable only runs within a single cabinet, you may also use a standard KNX-cable which we advice as standard cable for a myTEM Free Topology network.

### 3.3 Free Topology Cable

A Server (Smart Server or Radio Server) not only uses the CAN-Bus (Bus Topology, Daisy-chain) to connect to extending modules. The extension is also possible in a Tree Topology. This can be achieved by use of a myTEM FT Base Modul. Such a Module can be regarded as a server between two types of CAN networks (250kB and 10kB). The myTEM FT Base Modul allows to integrate modules in star bus topology. Each FT Base Modul provides two outputs (two branches) to connect up to 50 flush mounted FT modules. Do only use deep flush boxes (60mm) or hollow-wall boxes.

Feasible cable for the **myTEM Free Topology**



VOKA EIB BUS 2x2x0,8 mm (Diameter)

**Cables have to be selected according to applicable rules in terms of flammability and dielectric strength.**

Standard cable	Pair No.	Diameter	Cross section	AWG	Loop resistance	EN 13501-6 class
VOKA EIB BUS	2 x 2	0,8 mm	0,5 mm <sup>2</sup>	20	73,2 Ω / km	Cca-s3 d2 a3

The Bus cable (2x2x0,8 mm) may run up to a length of 500 m per branch.

## 4 Range of products

### 4.1 myTEM Smart Home System with Smart Server

Wired system for a single server installation. Extension modules (I/O, Dimmer, Relay, Dali) can be connected via the myTEM CAN Bus. Only a pure Bus Topology (line structure, daisy chain) is acceptable for a CAN Bus installation. A Radio Base Modul can also be used to integrate a Radio Network of Z-Wave devices.



The CAN Bus works with 250kBit/s. At this baud rate the cable length is limited to 250m with a standard CAN cable. Line losses (cross-section, quality) can additionally limit this maximum length of the line. The Bus is designed in pure Bus Topology and must be terminated correctly. The Smart Server is located at one end of the Bus, as a 120 Ohm terminating resistor is permanently installed.

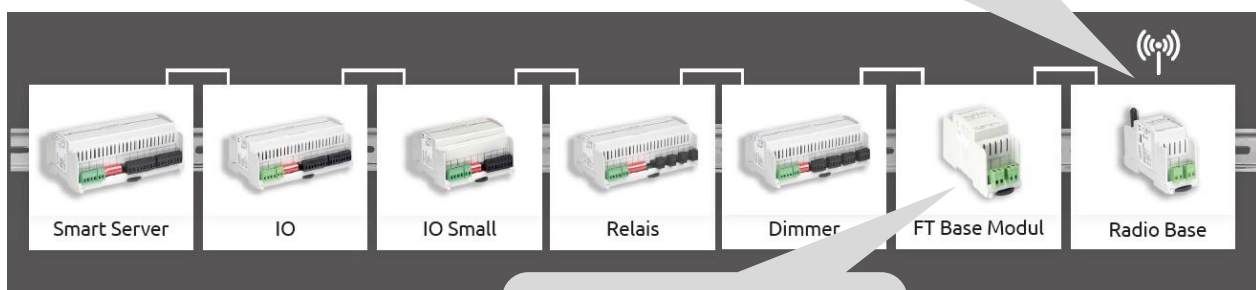

The myTEM Radio Base Modul (wireless) integrates Z-Wave devices.



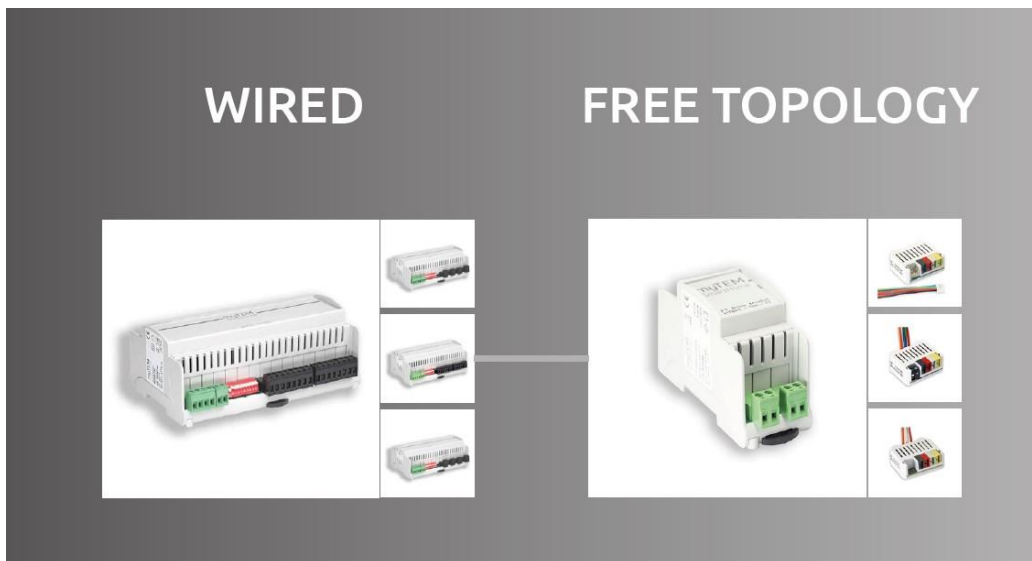

The FT Base Modul (Free Topology) allows networking in a free topology.



The following wired CAN-products are available in the myTEM System. The table only shows main features and the most important installations instructions. Please regard the comprehensive guidance in the operating manual of each product.

	<p><b>Smart Server MTSER-100, Part. No. 805613</b></p> <p>Interface:</p> <ul style="list-style-type: none"> <li>- CAN: up to 32 modules wired (One 120 Ohm terminating resistor permanently installed between CAN- and CAN+)</li> <li>- LAN: Connection to a router, a local network</li> <li>- 8 digit inputs (24 VDC)</li> <li>- 4 analogue inputs (0 ... 10V/ NTC/ PTC/ PT1000/ digital usable)</li> <li>- 4 analogue outputs (0 ... 10 VDC, 20mA)</li> <li>- 8 potential-free outputs (relay 8A/ 250VAC or 30 VDC)</li> </ul> <p>Installation notes:</p> <ul style="list-style-type: none"> <li>- Do not apply low voltage (ELV) and mains voltage together to inputs or outputs</li> <li>- Different voltages (e.g. 24 VDC, 230 VAC L1 or 230 VAC L2) may only be connected to the digital outputs (relays) <b>if one output is left out between them.</b></li> <li>- If several motors are connected in parallel at one output, use isolating relay if necessary</li> <li>- Only use blind motors with limit switches</li> <li>- Do not connect three-phase motors</li> </ul>
	<p><b>IO Modul MTIOM-100, Part No. 805625</b></p> <ul style="list-style-type: none"> <li>- 12 digital inputs (24 VDC)</li> <li>- 4 analogue inputs (0 ... 10 V/ NTC/ PTC/ PT1000U/ digital usable)</li> <li>- 4 analogue outputs (0 ... 10 VDC, 20mA)</li> <li>- 8 potential-free outputs (relay 8A/ 250VAC or 30 VDC)</li> </ul> <p>Installation notes:</p> <ul style="list-style-type: none"> <li>- Do not apply low voltage (ELV) and mains voltage together to inputs or outputs</li> </ul>

	<ul style="list-style-type: none"> <li>- Different voltages (e.g. 24 VDC, 230 VAC L1 or 230 VAC L2) may only be connected to the digital outputs (relays) <b>if one output is left out between them.</b></li> <li>- If several motors are connected in parallel at one output, use isolating relay if necessary</li> <li>- Only use blind motors with limit switches</li> <li>- Do not connect three-phase motors</li> </ul>
	<p><b>IO Modul Small MTIOM-100, Part No. 805626</b></p> <ul style="list-style-type: none"> <li>- 6 digital inputs (24 VDC)</li> <li>- 2 analogue inputs (0 ... 10 V/ NTC/ PTC/ PT1000/ digital usable)</li> <li>- 2 analogue outputs (0 ... 10 VDC, 20mA)</li> <li>- 4 potential-free outputs (relay 8A/ 250VAC or 30 VDC)</li> </ul> <p>Installation notes:</p> <ul style="list-style-type: none"> <li>- Do not apply low voltage (ELV) and mains voltage together to inputs or outputs</li> <li>- If several motors are connected in parallel at one output, use isolating relay if necessary</li> <li>- Only use blind motors with limit switches</li> <li>- Do not connect three-phase motors</li> </ul>
	<p><b>Dimmer Modul MTDIM-100, Part No. 805627</b></p> <ul style="list-style-type: none"> <li>- Digital inputs (24 VDC)</li> <li>- 4 analogue outputs (control of phase cut-on and phase cut-off) for: <ul style="list-style-type: none"> <li>o Switching and dimming filament or halogen lamps</li> <li>o Switching and dimming of dimmable inductive transformes with halogen or LED lamps</li> <li>o Loads: 4 x 250W for resistive, capacitive and inductive loads. The maximum cable length to a load is 20m</li> </ul> </li> </ul> <p>Installation notes:</p> <ul style="list-style-type: none"> <li>- Do not apply low voltage (ELV) and mains voltage together to inputs or outputs</li> <li>- Do not connect lights with integrated dimmer!</li> <li>- Only connect LED or compact fluorescent lamps that are expressly suitable for dimming</li> <li>- Only use primary-side fused safety transformers to IEC/EN 61558-2-6</li> </ul>
	<p><b>Relais Modul MTREL-100, Part No. 805628</b></p> <ul style="list-style-type: none"> <li>- 12 potential-free outputs (relay 8A/ 250 VAC or 30 VDC)</li> </ul> <p>Installations notes:</p> <ul style="list-style-type: none"> <li>- Do not apply low voltage (ELV) and mains voltage together to inputs or outputs</li> <li>- If several motors are connected in parallel at one output, use isolating relay if necessary</li> <li>- Only use blind motors with limit switches</li> <li>- Do not connect three-phase motors</li> </ul>

	<p><b>DALI Modul MTDAL-100, Part No. 805629</b></p> <ul style="list-style-type: none"> <li>- Up to 64 DALI products can be controlled via the DALI Bus</li> </ul> <p>Installation notes:</p> <ul style="list-style-type: none"> <li>- The DALI Bus requires an external DALI switch-mode power supply unit to function correctly. The voltage on the DALI Bus is typically 16V. It is essential to pay attention to the polarity of the power supply</li> <li>- The maximum voltage drop between transmitter and actuator must not be greater than 2V</li> <li>- The maximum cable length is 300m with 1.5 mm<sup>2</sup> conductors</li> <li>- Both linear and star topology are possible for DALI installations</li> <li>- It is not recommended to install DALI in combination with the mains cable</li> </ul>
	<p><b>FT Base Modul-MTBAS-100-FT, Part No. 805688</b></p> <ul style="list-style-type: none"> <li>- This product integrates up to 231 Z-Wave wireless products into a Smart Server network. We recommend a maximum of 50 wireless products. The Radio Base Modul works as a primary controller and should be placed centrally in the radio network. If mounted in a control cabinet, the external antenna myTEM MTANT-100-WL should be used</li> </ul> <p>Installation notes:</p> <ul style="list-style-type: none"> <li>- Up to 4 myTEM Radio Base Modules with the same myTEM Smart Server can be used on the CAN Bus. This can be useful for example when flats are to have their own independent Z-Wave networks with a central server</li> </ul>
	<p><b>Antenna with cable/MTANT-100-WL, Part No. 115082</b></p> <ul style="list-style-type: none"> <li>- Suitable accessories for Radio Base Modul and Radio RGBW Modul.</li> <li>- Cable length 2 meters</li> <li>- Simple industrial design</li> <li>- Improves the radio range of the devices in the control cabinet</li> </ul>

## 4.2 myTEM Smart Home System in Free Topology



Pure Bus Topology is not the only way to extend a single server installation (Smart Server or Radio Server). The myTEM FT Base Modul can be considered as a data server between the two CAN networks (250kB and 10kB). At the same time it is possible to break up this pure Bus topology by use of the myTEM FT Base Modul. The myTEM FT Base Modul allows the connection of 2 knots in free tree topology at its output side. Each knot allows the connection of up to 50 flush-mounted modules. Only use deep (60mm) flush boxes or cavity sockets. The Bus cable (2x2x0,8mm) can have a total length of up to 500m per knot.



The myTEM Topology products at an overview:

	<p><b>FT Base Modul-MTBAS-100-FT, Part No. 805688</b></p> <p>The myTEM FT Base Modul expands the CAN network with products from the myTEM Free Topology range.</p>
--	--



	<p>Installation notes:</p> <ul style="list-style-type: none"> <li>- If more than one power supply is installed at a site, all GND's have to be interconnected at one point. A shared reference potential (GND) is necessary for interference-free bus communication</li> </ul>
	<p><b>FT DIN SIX-MTDIN-100-FT, Part No. 805689</b></p> <ul style="list-style-type: none"> <li>- Reading of up to 6 buttons, switches or contacts</li> <li>- 4 digital inputs (24VDC)</li> <li>- 2 analogue inputs (0...10VDC, NTC, PTC, PT1000 or digital) Connector for flat cable to connect the room control myTEM Touch Add-on Glossy</li> </ul> <p>Installation notes:</p> <ul style="list-style-type: none"> <li>- For the push-in terminals use solid wire) 0.6 to 1.0 mm diameter / AWG 19,20,21) stripped to 5-6 mm</li> </ul>
	<p><b>FT RGBW Modul-MTRGB-100-FT, Part No. 805691</b></p> <ul style="list-style-type: none"> <li>- RGBW Modul for operating dimmers, 4-colour LED strips or 4-colour LED lamps (2A per LED channel)</li> <li>- Screw terminals (up to 2.5mm<sup>2</sup>) for 12VDC or 24VDC supply voltage for LED strips or LED lamps</li> </ul> <p>Installation notes:</p> <ul style="list-style-type: none"> <li>- Small distance between RGBW Modul and LED lighting</li> <li>- Maximum voltage fall on the supply line: 1V</li> <li>- 2m maximum cable length on the output side</li> <li>- Solid wire (0.6 BIS 1.0 mm diameter / AWG 19,20,21) stripped 5-6 mm must be used for the push-in terminals</li> </ul>
	<p><b>FT Switch Dimmer-MTSDW-100-FT, Part No. 805692</b></p> <ul style="list-style-type: none"> <li>- Switching and dimming the lighting (0 ... 250W / 230VAC)</li> <li>- Current and energy consumption measurement of the connected device</li> </ul> <p>Installation notes:</p> <ul style="list-style-type: none"> <li>- Supply voltage 24VDC with support terminals (screw terminals 2.5mm<sup>2</sup>) for further wiring</li> <li>- Only with short lines and a low voltage fall can the device alternatively be supplied via the Bus cable (24V, GND)</li> <li>- The cable length to the load should not exceed 10m</li> </ul>



**FT Switch Dual-MTSWI-100-FT, Part No. 805690**

- Switching of 2 electrical devices (2 x 6A / 250VAC)
- Current and energy consumption measurement of the connected device

Installation instructions:

- The two loads are fed via a common supply line (middle terminal)

### Example: Typical installation in residential construction

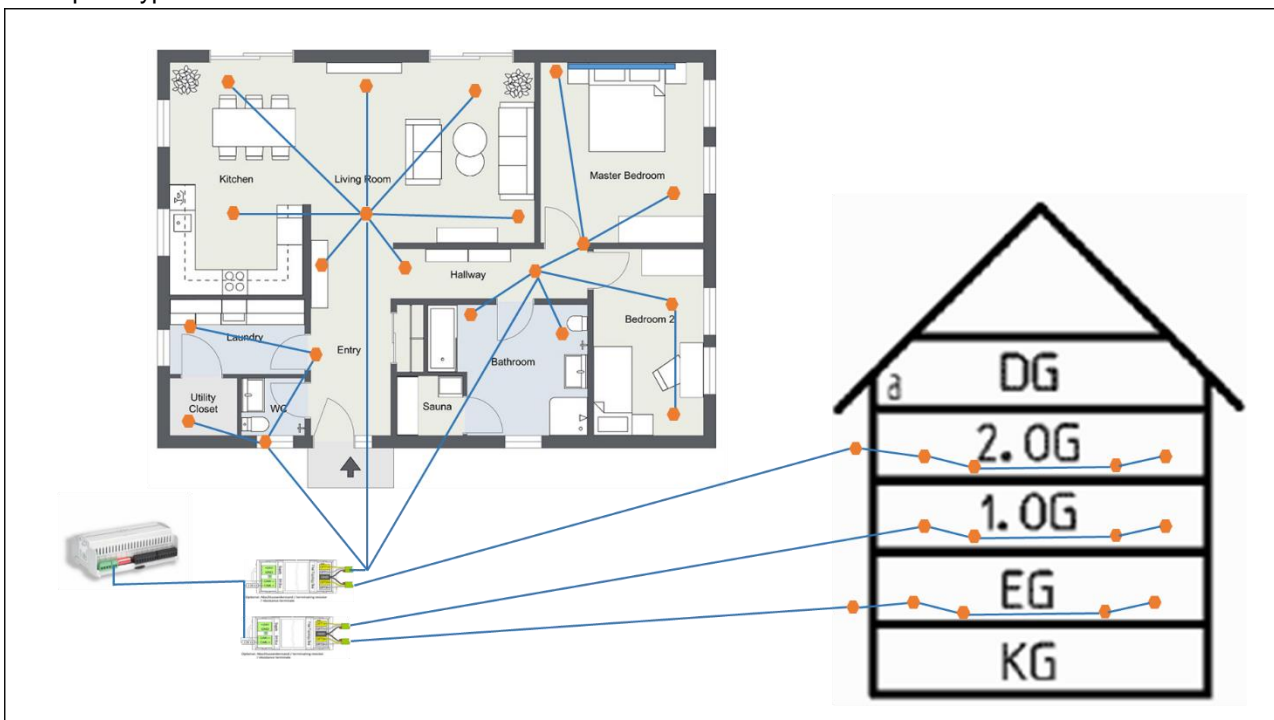

This example illustrates the advantage of Free Topology. An outlet of the FT Base Modul is the star point from which all lines lead in a star shape into the individual rooms of a floor. The total length of the Bus cable installed on a floor may reach 500m. This type of cable routing is called tree topology. Up to 50 flush-mounted modules can be connected to a CFT (CAN Free Topology) connector via the Bus cable in the deep wall boxes of the rooms.

The two FT Base Modules are connected to a Smart or Radio server via CAN Bus.

### 4.3 myTEM Smart Home System with Radio Server



Wireless network for a single server installation. The Radio Server is the interface to the Radio network of Z-Wave devices. The Radio Server also has a CAN interface, which can be used to connect wired extension modules (I/O, Dimmer, Relay, DALI, etc.). Only a pure Bus topology (line structure, daisy chain) is permitted for CAN Bus installation. The CAN Bus works at 250kBit/s. The cable length is limited to 250m with our standard cable. The Bus must be terminated correctly. The Radio Server is located at one end of the Bus, because a 120 Ohm terminating resistor is permanently installed. A Radio Server creates the connection to a Z-Wave Radio network.

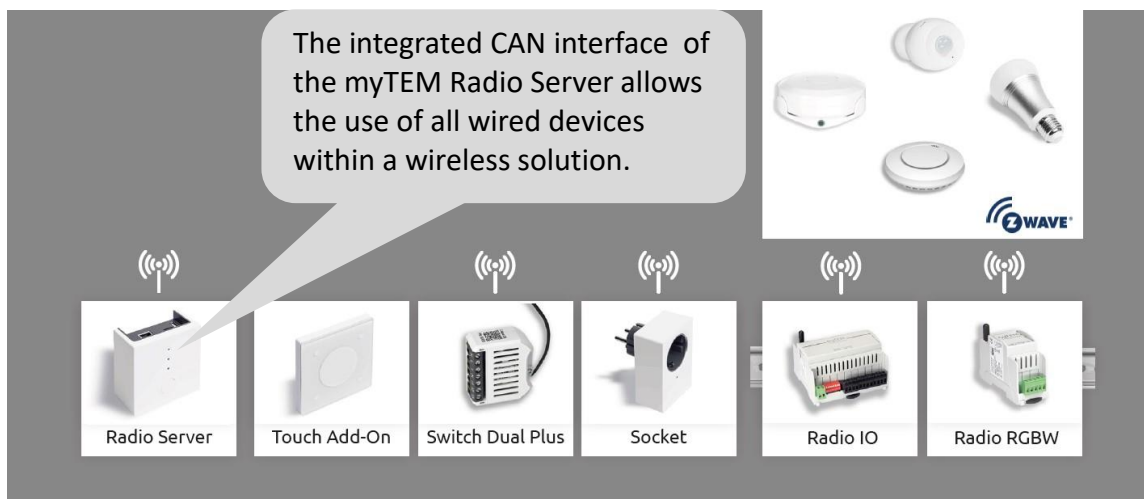

A Smart Server can also be extended with a Radio network. To enable our wired system to receive information or output control signals via Radio signal, a myTEM Radio Base Modul is connected to the CAN network of the Smart Server. Radio Base or Radio Server are primary controllers in the Z-Wave network. Z-Wave uses the Radio frequency 868.4 MHz. Telegrams are AES encrypted and the security architecture version 2 (S2) is used. Up to 231 Z-Wave devices can be integrated (included), which work with or without secure communication (S2). These may also be Z-Wave products from other manufacturers. In such cases



we recommend that you consult our support department before using such devices. It is recommended to place a Z-Wave device approximately every 10 meters or even closer for maximum efficiency. Line-powered devices act as repeaters in the Z-Wave network, forwarding radio telegrams (Hop). Radio telegram routes can extend over up to 4 intermediate hops (max. range typically at least 60m / up to 200m under perfect conditions).



You can also find answers to technical questions on our website:



<https://www.mytem-smarthome.com/web/en/faq/>

You can also find further information on understanding the Z-Wave Radio standard at:





[https://z-wavealliance.org/about\\_z-wave\\_technology](https://z-wavealliance.org/about_z-wave_technology)





The following wireless (Funk) products are available in the myTEM System:

	<p><b>Radio Server MTSER-100-WL, Part No. 805614</b></p> <p>Interface:</p> <ul style="list-style-type: none"> <li>- CAN: up to 32 modules wired</li> <li>- Funk: primary controller of a Z-Wave network</li> <li>- LAN: Connection to a router, a local network</li> </ul> <p>Installation notes:</p> <ul style="list-style-type: none"> <li>- The Radio Server is not mounted in a control panel. The unit is suitable for wall mounting</li> <li>- Power supply (5V) via USB type C power supply unit</li> <li>- The CAN connector must be connected to ground (<math>\perp</math> to GND)</li> </ul>
	<p><b>Radio RGBW Modul MTRGBW-100-WL, Part No. 805615</b></p> <ul style="list-style-type: none"> <li>- Switching and dimming of 4-colour LED strips, max. 50W per LED channel</li> </ul> <p>Installation notes:</p> <ul style="list-style-type: none"> <li>- The RGBW Modul must be supplied by a 24VDC power supply</li> <li>- Mounting in control panel</li> <li>- Recommendation: maximum length of LED strips: 10m</li> <li>- connect several LED strips in parallel and not in series to one RGBW output</li> </ul>
	<p><b>Radio Switch Dual-100-WL, Part No. 805618</b></p> <p>Either 110-230VAC or 24 VDC is approved as the operating voltage. This voltage is output via both relays.</p> <ul style="list-style-type: none"> <li>- 2 relays for switching 230 VAC (max. 6A) or 24 VDC (max. 6A)</li> <li>- 2 digital inputs detect the switching of the operating voltage (230VAC or 24VDC) to GND. This allows conventional 230VAC switches to be detected</li> <li>- Current and energy consumption measurement of the connected loads</li> </ul> <p>Installation notes:</p>

	<ul style="list-style-type: none"> <li>- Installation in a 60mm hollow wall socket, for example behind switches or sockets</li> <li>- maximum cable length between Radio Switch and a switch or load: 10m</li> <li>- Place the antenna upright and as far away as possible from metal parts and cables for optimum range. Attention: Do not shorten the antenna!</li> </ul>
	<p><b>Radio Switch Dual Plus-101-WL, Part No. 805638</b></p> <p>Either 110-230VAC or 24 VDC is approved as the operating voltage. This voltage is output via both relays.</p> <ul style="list-style-type: none"> <li>- 2 relays for switching 230 VAC (max. 6A) or 24 VDC (max. 6A)</li> <li>- 2 digital inputs detect the switching of the operating voltage (230VAC or 24VDC) to GND. This allows conventional 230VAC switches to be detected</li> <li>- Connector for ribbon cable to connect the room control unit myTEM Touch Add-on Glossy</li> </ul> <p>Installation notes:</p> <ul style="list-style-type: none"> <li>- Installation in a 60mm hollow wall socket, for example behind switches or sockets</li> <li>- maximum cable length between Radio Switch and a switch or load: 10m</li> <li>- Place the antenna upright and as far away as possible from metal parts and cables for optimum range. Attention: Do not shorten the antenna!</li> </ul>
	<p><b>Radio Switch Shutter Plus, MTSWIS-101-WL, Art. Nr. 805708</b></p> <p>Either 110-230VAC or 24 VDC is approved as the operating voltage. This voltage is output via both relays.</p> <ul style="list-style-type: none"> <li>- 2 relays for switching 230 VAC (max. 6A) or 24 VDC (max. 6A)</li> <li>- 2 digital inputs detect the switching of the operating voltage (230VAC or 24VDC) to GND. This allows conventional 230VAC switches to be detected</li> <li>- The endpositions of the blinds are detected by monitoring the current consumption.</li> <li>- Connector for ribbon cable to connect the room control unit myTEM Touch Add-on Glossy</li> </ul> <p>Installation notes:</p> <ul style="list-style-type: none"> <li>- Installation in a 60mm hollow wall socket, for example behind switches or sockets</li> <li>- maximum cable length between Radio Switch and a switch or load: 10m</li> <li>- Place the antenna upright and as far away as possible from metal parts and cables for optimum range. Attention: Do not shorten the antenna!</li> </ul>

	<p><b>Radio Switch Dimmer, MTSWD-100-WL, Art. Nr. 805655</b></p> <ul style="list-style-type: none"> <li>- Operating voltage is 230 VAC / 50 Hz</li> <li>- Analog output 250 W for resistive, capacitive and inductive loads with leading edge or trailing edge phase cutting control: <ul style="list-style-type: none"> <li>• Switching and dimming filament or halogen lamps</li> <li>• Switching and dimming of dimmable inductive transformes with halogen or LED lamps</li> </ul> </li> <li>- 3 digital inputs detect the switching of the operating voltage (230VAC or 24VDC) to GND. This allows conventional 230VAC switches to be detected.</li> <li>- Current and energy consumption measurement of the connected loads</li> </ul> <p>Installation notes:</p> <ul style="list-style-type: none"> <li>- Installation in a 60mm hollow wall socket, for example behind switches or sockets</li> <li>- maximum cable length between Radio Switch Dimmer and a switch or load: 10m</li> <li>- Place the antenna upright and as far away as possible from metal parts and cables for optimum range. Attention: Do not shorten the antenna!</li> </ul>
	<p><b>Touch Add-On Glossy MTTOU-500, Part No. 805619</b></p> <ul style="list-style-type: none"> <li>- Room operative using 5 touch-sensitive touch field</li> <li>- Connectable to Radio Switch Dual Plus, Radio Switch Shutter Plus or FT DIN SIX (Free Topology)</li> </ul> <p>Functional features:</p> <ul style="list-style-type: none"> <li>- Integrated temperature sensor</li> <li>- Integrated humidity sensor</li> </ul> <p>Installation notes:</p> <ul style="list-style-type: none"> <li>- Wall mounting above a cavity wall socket</li> </ul>
	<p><b>Radio Socket EU MTSOC-100-WL, Part No. 805623</b></p> <ul style="list-style-type: none"> <li>- Typ F (EU) up to 3600W</li> <li>- Current and energy consumption measurement of the connected loads</li> </ul> <p>Functional features:</p> <ul style="list-style-type: none"> <li>- Integrated temperature sensor</li> <li>- Integrated humidity sensor</li> </ul> <p>Installation notes:</p> <ul style="list-style-type: none"> <li>- Only one device can be connected in per socket</li> <li>- The connection of several devices is not permitted</li> <li>- Make sure that the electrical load of the u controlling device does not increase 3600 watts</li> </ul>
	<p><b>Radio Socket CH MTSOC-100CH-WL, Part No. 805622</b></p> <ul style="list-style-type: none"> <li>- Type J (CH) loads up to 2300W</li> <li>- Current and energy consumption measurement of the connected loads</li> </ul>

	<p>Functional features:</p> <ul style="list-style-type: none"> <li>- Integrated temperature sensor</li> <li>- Integrated humidity sensor</li> </ul> <p>Installation instructions:</p> <ul style="list-style-type: none"> <li>- Only one device can be plugged in per socket</li> <li>- The connection of several devices is not permitted</li> <li>- Make sure that the electrical load of the u controlling device does not exceed 2300 watts</li> </ul>
	<p><b>Radio IO Modul, Part No. 805624</b></p> <ul style="list-style-type: none"> <li>- Z-Wave universal IO module</li> <li>- 6 Digital inputs 24 VDC</li> <li>- 4 analogue inputs (O ... 10V/ NTC/ PTC/ PT1000/ digital useable)</li> <li>- 6 potential-free outputs (relay 8A / 250VAC) can be overridden by DIP switch</li> </ul> <p>Installation notes:</p> <ul style="list-style-type: none"> <li>- Different voltages (e.g. 24 VDC, 230 VAC L1 or 230 VAC L2) may only be connected to the digital relay outputs if one output remains FREE in between</li> <li>- If mounted in a control panel the external antenna myTEM MTANT-100-WL should be used</li> </ul>
	<p><b>Radio IO Modul Floor, Part No. 805686</b></p> <ul style="list-style-type: none"> <li>- Z-Wave universal IO module</li> <li>- 6 Digital inputs 24 VDC</li> <li>- 4 analogue inputs (O ... 10V/ NTC/ PTC/ PT1000/ digital useable)</li> <li>- 6 noiseless potential-free outputs (SSR 0.05A / 250VAC) can be overridden by DIP switch</li> </ul> <p>Installation notes:</p> <ul style="list-style-type: none"> <li>- Different voltages (e.g. 24 VDC, 230 VAC L1 or 230 VAC L2) may only be connected to the digital relay outputs if one output remains FREE in between</li> <li>- If mounted in a control panel the external antenna myTEM MTANT-100-WL should be used</li> </ul>
	<p><b>Radio Window Door Contact, Part No. 805633</b></p> <ul style="list-style-type: none"> <li>- Z-Wave door/ window contact</li> <li>- Battery supply CR2 (3V), battery life ~ 1 year</li> </ul> <p>Installation notes:</p> <ul style="list-style-type: none"> <li>- Mounting with screws or adhesive tape</li> <li>- When installing the door/ window sensor, mount the contact body on the curved side of the main body (groove)</li> </ul>

	<p><b>Radio Bulb, Part No. 805635</b></p> <ul style="list-style-type: none"> <li>- Z-Wave lamp (100 – 240 VAC / 7W / E27)</li> <li>- Maximum brightness: 60lm</li> <li>- Memory the selected lighting scene</li> </ul>
	<p><b>Radio Motion, Part No. 805636</b></p> <ul style="list-style-type: none"> <li>- Z-Wave motion detector</li> <li>- Battery supply CR123A (3V), battery life ~ 1 year or supply via microUSB</li> </ul> <p>Installation notes:</p> <ul style="list-style-type: none"> <li>- Mounting in a shelf, in a corner of the room, on a wall or ceiling</li> <li>- Maximum range: 7m</li> </ul>
	<p><b>Radio Sirene, Part No. 805642</b></p> <ul style="list-style-type: none"> <li>- Z-Wave alarm siren</li> <li>- Battery supply 2 x CR123A (3V), battery life ~ 1 year</li> <li>- Optical and acoustic (10 sounds) signal</li> </ul> <p>Installation notes:</p> <ul style="list-style-type: none"> <li>- Installation in an easily accessible location</li> </ul>
	<p><b>Radio Leakage, Part No. 805644</b></p> <ul style="list-style-type: none"> <li>- Z-Wave Water Sensor</li> <li>- Battery supply 1 x CR2 (3V), battery life ~ 2 years</li> </ul> <p>Installation notes:</p> <ul style="list-style-type: none"> <li>- Screw the water sensor to the floor</li> <li>- Do not install in a place with standing water</li> <li>- Do not install near steam or smoke</li> </ul>
	<p><b>Radio Valve, Part No. 805634</b></p> <ul style="list-style-type: none"> <li>- Z-Wave energy saving controller for small valves (thread M30x1.5)</li> <li>- Battery supply 2 x LR6 AA (1.5)</li> </ul> <p>Installation instructions:</p> <ul style="list-style-type: none"> <li>- No adapter is necessary for the following valves: Heimeier, Junkers, Landis+Gyr, MNG, Honeywell, Brakmann</li> <li>- Adapters for the following valves are included: Danfoss RAV, RA and RAVL</li> <li>- For further information on valve mounting, please visit: <a href="https://eurotronic.org/service/faq">https://eurotronic.org/service/faq</a></li> </ul>

## 5 Supply voltage

### 5.1 Overview

The DC 24V supply must be correctly dimensioned. This ranges from the AC fuse to the switched-mode power supply and the DC overcurrent protection. These components ensure trouble-free operation. The myTEM power supplies protect against short circuit, overvoltage, electrical and thermal overload.

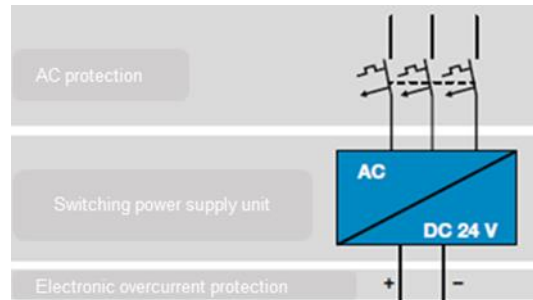



### 5.2 24V Power supplies

The myTEM power supplies are DIN rail power supplies in slim design. They can be mounted on a standard TS35 DIN rail.

myTEM power supplies:

(LPS = Limited Power Source according to IEC/EN 62368-1 and IEC/EN 60950-1)

Type	Max. Power	Max. Performance	Dimensions	Recommended protection
 Power supply 36W/MTPOW-100	1.5 A	30W	35 x 90 x 54.5mm, 2TE/2SU	T3, 15A/H250V Characteristics C12
 Power supply 92W/MTPOW-101	3,83 A	100W	70 x 90 x 54.5mm, 4TE/4SU	T3, 15A/ H250V, Characteristics C7
 Power supply 240W/MTPOW-102	10 A	240W	63 x 125.5 x 113.5	T5, 0A/ L250V, Characteristics C4

### 5.2.1 Installation

- Always ensure good ventilation clearances, 5mm left and right, 40mm top and 20mm bottom, around the equipment in use to avoid overheating. A distance of 10-15 cm must also be maintained if the adjacent device is a heat source.
- The corresponding mounting position of the device is vertical, the input terminals are at the bottom and the output is at the top. Any other mounting position than this, such as upside down, horizontal or table mounting, is not permitted.

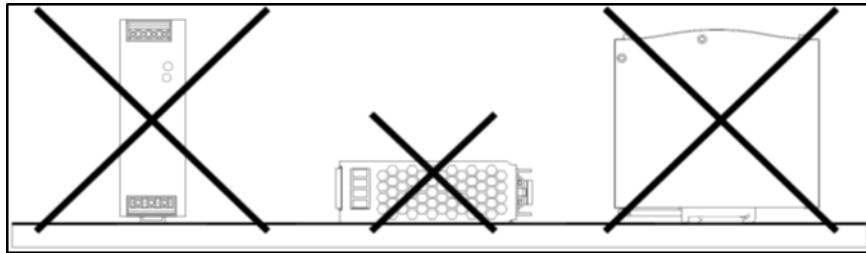

### 5.2.2 Power Assignment supply cable

If our standard cables are used for power supply, the maximum current carrying capacity specified in the table is valid. The values refer to an ambient temperature of 30°C. At 60°C the value decreases to 6A (CAN) or 3.75A (FT-CAN).

Bus	cross section	AWG	rated current (A)
CAN	0,75 mm <sup>2</sup>	19	12
FT-CAN	0,50 mm <sup>2</sup>	20	7,5

When your bus cable only runs within a cabinet, our FT-CAN standard cable (EIB/KNX) may be used as well. In that case, all specs of the FT-CAN are valid.

### 5.3 Power consumption

Calculate the total power consumption of all connected myTEM devices.

CAN Modul	Type	No I/O active	All I/O,s active**	Operating voltage [V]
	Smart Server MTSER-100	0,6W	4,7W	21,6 ... 26,4
	IO Modul MTIOM-100	0,4W	4,5W	21,6 ... 26,4
	IO Modul Small MTIOS-100	0,4W	2,5W	21,6 ... 26,4
	Relais Modul MTREL-100	0,4W	6,8W	21,6 ... 26,4
	Dimmer Modul MTDIM-100	0,4W	1,6W	21,6 ... 26,4
	Radio Base Modul MTBAS-100-WL	0,8W	0,8W	21,6 ... 26,4
	DALI Modul MTDAL-100	0,4W	0,4W	21,6 ... 26,4
Free Topology	FT Base Modul MTBAS-100-FT	0,28W	0,28W	21,6 ... 26,4
	FT DIN SIX MTDIN-100-FT	0,14W	0,14W	10 ... 26
	FT RGBW Modul MTRGB-100-FT	0,1W	0,1W	10 ... 26
	FT Switch Dual MTSWI-100-FT	0,1W	0,1W*	10 ... 26
	FT Switch Dimmer MTSWD-100-FT	0,26W	0,26W	10 ... 26

\* The FT Switch Dual uses latching relays to switch the loads. Therefore the current consumption will only raise while switching the relays (0.1s) and thus may be ignored.

\*\* The ratings of the power consumption only represent the devices themselves and does not include external loads such as lamps.



The Radio Server MTSER-100-WL does not need to be considered here, as it is supplied separately (USB).

You have to add up the consumption of all modules connected to a 24VDC supply line. Active inputs or outputs (relay, 1...10V, MOSFET) increase the current consumption. However, since not all outputs are constantly active at the same time, you may calculate a factor of simultaneity here.

**Example:** 5 \* MTREL-100:34W simultaneity factor 0.5 (30 of the 60 relay active)  $34*0.5=17W$ .  
(the exact calculation would be:  **$5*0.4W + ((6.8W-0.4)*5)*0.5=18W$** )

If several power supply units are required to supply all 24V modules in one line, the GND,s should be interconnected.

## 5.4 Rule of thumb for designing the Free Topology Network

If the total length of all cable outlets at a Free Topology Base Modul star point outlet does not exceed 250m, you can place up to 30 FT flush-mounted modules in any combination on your floor or building without making an exact calculation. At the last module, 12.5 V still arrive at the bus cable of the type YCYM (2x2x0.8mm). This rule of thumb provides sufficient power reserves.

## 5.5 Example of power consumption calculation

If the myTEM devices are connected to a DC power supply, it is important to ensure that a high enough voltage is applied to the individual modules so that each module functions safely. Please observe the specified ranges of the permissible operating voltage. The specified minimum voltage must be applied to a module under full load to ensure safe operation.

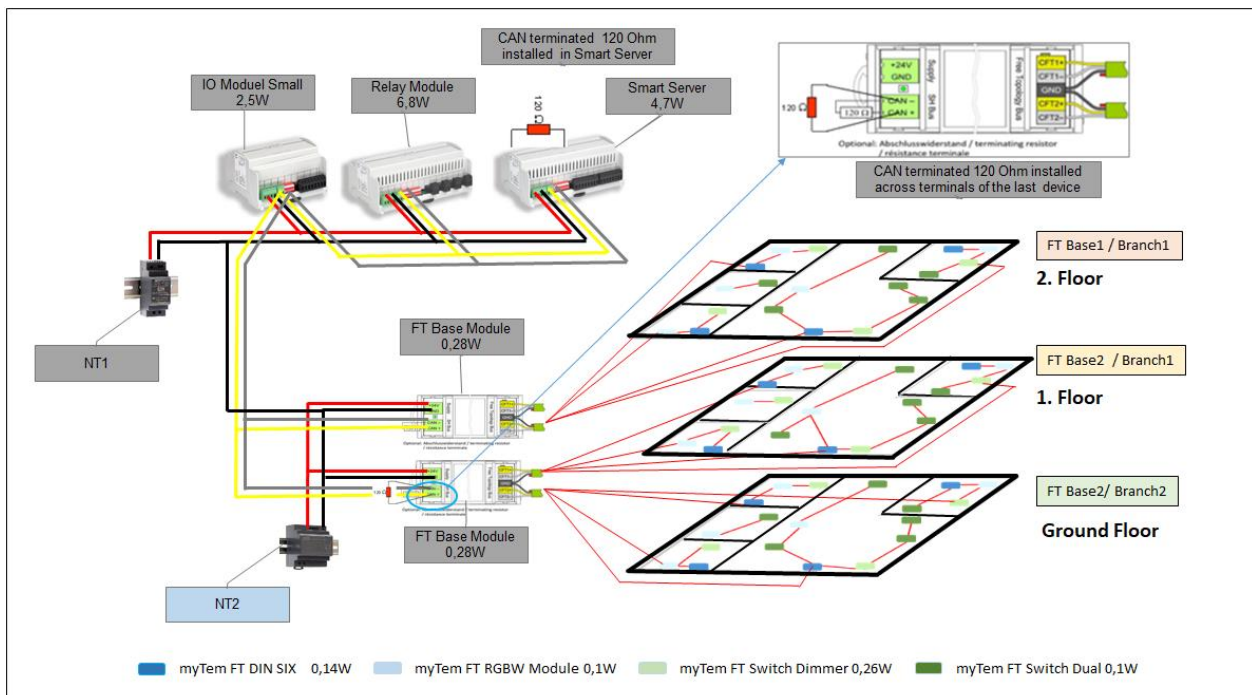

The total cable length per knot is 150m.

The example shows that an FT Base Modul is to be seen as a star point. A FT Base Modul is part of the CAN Bus of a server and has 2 output terminals to form 2 star points. Ideally, all Free Topology flush-mounted modules of a room are connected to a star point via a cable. The lengths of all cables that depart from a star point result in the total length of that "knot". The total length can reach to 500m. Up to 50 Free



Topology flush-mounted modules can be connected to one knot. Using the second star point (second knot), another 50 Free Topology flush-mounted modules can be added to the network via 500m Bus line, as shown in the example.

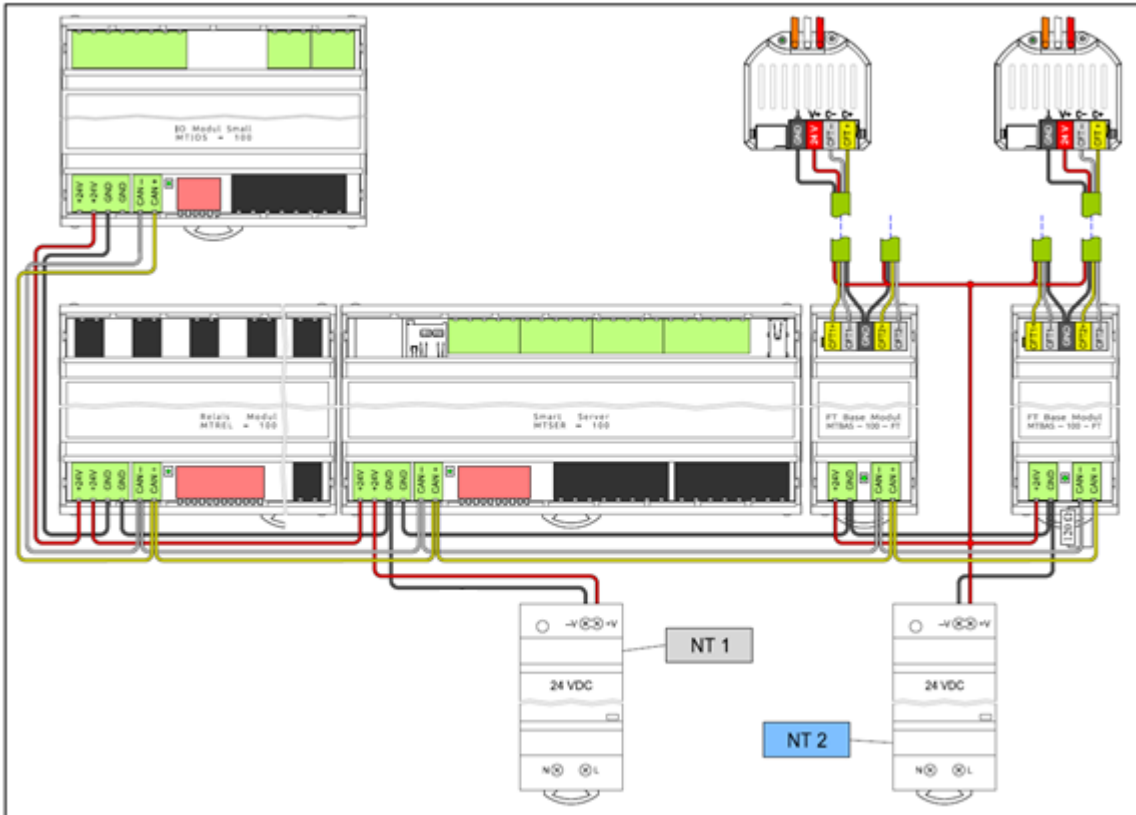

This example shows the Smart server connected to the two FT base Modules. Not all myTEM CAN Modules are shown in the wiring diagram above. Each FT Base Modul provides 2 Branches (star knots). In this example all FT flush-mounted modules (max. allowed: 50 / rule of thumb: 30) are powered by a single power module. This power module is rated in a way that even the most remote device will be supplied sufficiently.

### 5.6 Power supply selection

The power supply selection in the example above is very simple. All devices that are fed by a power supply unit have to be calculated.

NT1	Devices	Quantity	Performace	Total
	myTEM Smart Server	1	4,7 W	4,7 W
	myTEM Relais Modul	1	6,8 W	6,8 W
	myTEM IO Modul Small	1	2,5 W	2,5 W
<b>Total power consumption</b>				<b>14 W</b>

The power supply unit delivers a current of 0,61A (14W/24V).

In this case smallest power supply unit myTEM HDR-30-24 is enough. A simultaneity factor does not have to be considered.

NT2	Devices	FT Base/Branch	Quantity	Performacne	Total
	myTEM FT Base Modul		2	0,28 W	0,56 W
	myTEM FT DIN Six	Base1 /Branch1	4	0,14 W	0,56 W

myTEM FT RGBE Modul (without Load)	Base1 /Branch1	5	0,1 W	0,5 W
myTEM FT Switch Dimmer	Base1 /Branch1	4	0,26 W	1,04 W
myTEM DT Switch Dual	Base1 /Branch1	6	0,1 W	0,6 W
myTEM FT DIN Six	Base2 /Branch1	4	0,14 W	0,56 W
myTEM FT RGBE Modul (without Load)	Base2 /Branch1	5	0,1 W	0,5 W
myTEM FT Switch Dimmer	Base2 /Branch1	4	0,26 W	1,04 W
myTEM DT Switch Dual	Base2 /Branch1	6	0,1 W	0,6 W
myTEM FT DIN Six	Base2 /Branch2	4	0,14 W	0,56 W
myTEM FT RGBE Modul (without Load)	Base2 /Branch2	5	0,1 W	0,5 W
myTEM FT Switch Dimmer	Base2 /Branch2	4	0,26 W	1,04 W
myTEM DT Switch Dual	Base2 /Branch2	6	0,1 W	0,6 W
<b>Total power consumption</b>				<b>8,66 W</b>

The power supply unit delivers a current of 0,36A (8,66W / 24V).

To provide the maximum 8,66W, the myTEM HDR-30-24 is also enough. A simultaneity factor must not be applied here, as the current consumption of the flush-mounted modules is valid for continuous operation.

Note: This calculation already regards the reduced power consumption of the FT Switch Dual. The FT Switch Dual uses latching relays and thus their power consumption will be higher only during switching (0.1s).

## 5.7 Line losses (Conduction losses)

For all wiring Bus systems the cable type YCYM (2x2x0,8mm) can be used. This cable type is also used in KNX installations.

Kabel / Leitungen KNX/EIB-Busleitung Eca J-Y(ST)Y  
2x2x0,8 RG100m grün



Conductor resistance:	73,2 Ohm/100m
Min. bending radius:	outside diameter
Temperature range:	-30 ... +70°C
Operating capacity:	Max. 100nF/1000m (800Hz)

Conductor colours:	Red: 24VDC
	Black: GND
	Yellow: CFT+ / CAN+
	White: CFT- / CAN-

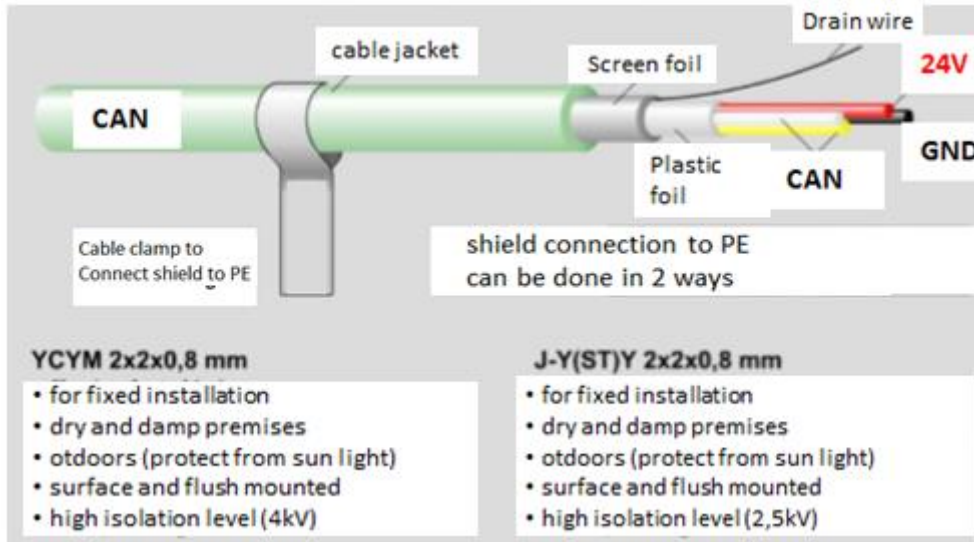

The red / dark grey (or black) wire pair is used for the supply voltage, yellow (CAN+) and white (or bright grey: CAN-) together with the supply ground are used for data communication. With long cable runs there is a considerable voltage drop. The maximum cable length should be determined so that at least 10VDC still arrives at the end of cable for the safe supply of a flush-mounted module. This can be checked with our online calculator, for example:

<https://www.mytem-smarthome.com/web/en/downloads/installation-guides>

## myTEM Wired Calculator



### Description

This table calculates the cable length and the necessary power supply (results without warranty). Input voltage is 24V. Copper wire is assumed for the calculations (0.0171 W mm<sup>2</sup>/m).

### Fields description

= Input fields	= Calculated parameters (do not change!)
----------------	--

### Calculator

This calculator can be used to determine the cable length and the necessary power supply, assuming that all myTEM Smart Home devices are connected to the cable end.

Cable length [m]	15.65
Cu conductor cross-section [mm <sup>2</sup> ]	0.75
Simultaneity factor [%]	50
<b>Devices</b>	<b>Number of devices</b>
Smart Server	6
IO Modul	10
IO Modul Small	6
Relais Modul	4
Dimmer Modul	6
Radio Base Modul	1
Dali Modul	6
FT Base Modul	6
Total output [W]	77.98
Power supply:	<b>"MTPOW-101 92W 3.83A"</b>

The myTEM calculator computes the max. cable run and the supply voltage that is necessary. The cable run is limited by a voltage drop of 2.4V (21,6V at the end of the line). Input fields are marked yellow.

## myTEM Free Topology Calculator

### Description

This table calculates the cable length and the necessary power supply (results without warranty)

**Calculator 1 or 2 give good estimates, branching on several branches improves the results. Calculators 3 and 4 are worst case cases.**

Input voltage is 24 VDC and the cable used for the calculations is a VOKA EIB BUS / 2x2x0.8mm.

### Fields description

= Input fields	= Calculated parameters (do not change!)
----------------	--

### Calculator 1

This calculator can be used to determine the required power supply (assuming that the myTEM FT devices are evenly distributed along the entire length). The voltage at the last device in the system is 12V.

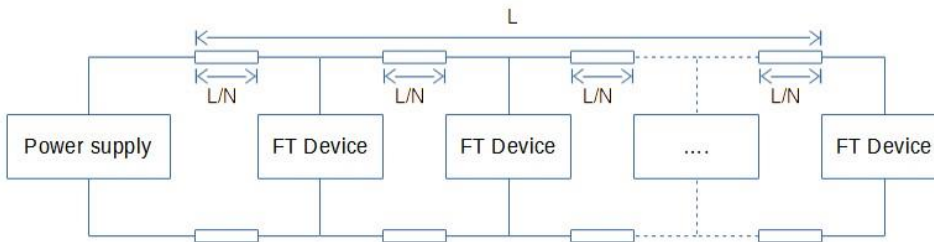

Cable length [m]	500
Devices	Number of devices
FT Din6	15
FT Dual	15
FT Dimmer	10
FT RGBW	10
Total output [W]	15.50
System is OK?	"MTPOW-100 36W 1.5A"

The myTEM Free Topology calculators will tell you which electrical output is required. Worst case scenario calculator 4 determines the longest possible cable run in way, that there will be at least 12VDC supply voltage at the end of the line. **We strongly advice to read the actual voltage at the most remote device when the installation is done.**

Calculator 4 can be used to proof the "rule of thumb". When 30 x FTSwitch Dual devices (12,14W) are entered, a maximum cable run of 320m is calculated. This is well on the safe side of our "rule of thumb" calculation. The calculator shows on the other hand, that an Installation with a cable run of 500m should not supply more than 8W of total power consumption.

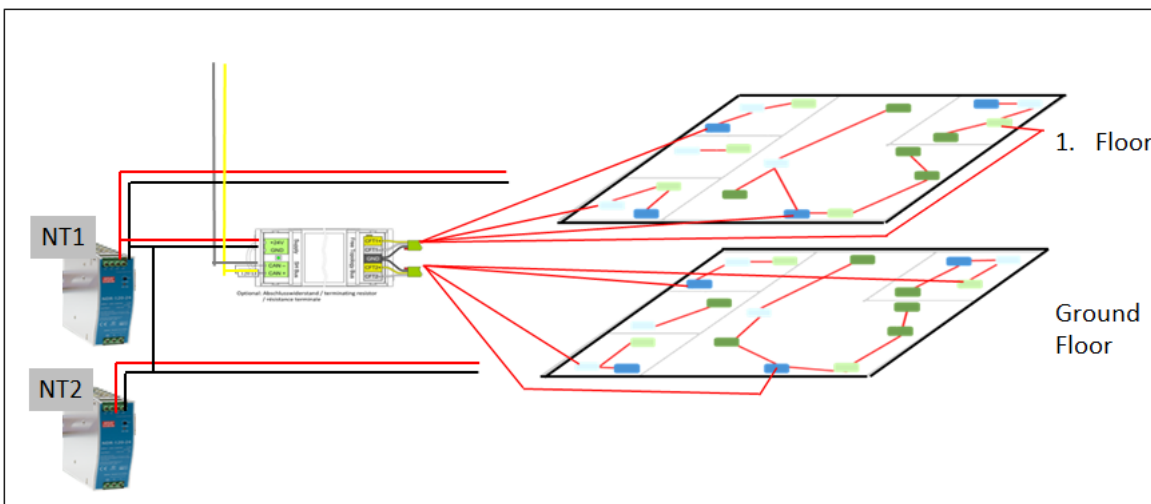

In this example the devices are connected by 2 power supply units. A common potential for all consumers is necessary for a reliable communication.

NT1: Power supply for FT Base Modul and all FT flusch mounted modules connected to knot1 (1.Floor).

NT2: Power supply for all FT flusch mounted modules connected to knot2 (Ground Floor)

## 6 myTEM wiring rules

### 6.1 CAN in Bus-Topology

#### a) Bus cable

We recommend a YCYM type canble (2x2x0.8mm<sup>2</sup>) when the complete installation is done within a cabinet. This cable type is also used in KNX installations.

When installations require a long cable run between various cabinets, a specific CAN-Cable (such as Voka Bus CAN 2x2x0,75mm<sup>2</sup>) should be used.

#### b) Maximum cable length and speed of data transmission

On this Bus, data is transmitted at 250kBit/s. The total length of the Bus cable may be up to 250m. Ideally, the cable is routed from device to device without the formation of cable stubs (stitches).

#### c) Maximum number of participants

Up to 31 CAN modules, (Dimmer, Relay, IO, IO Small, DALI, Radio Base Modul) can be connected to one server (Smart or Radio Server)

#### d) Topology

Only a pure Bus Topology (daisy chain, line topology, line chain) is acceptable.

#### e) Termination

The CAN Bus must be terminated at both Bus ends with a 120 Ohm resistor. Our servers (Smart Server / Radio Server) already have a 120 Ohm resistor integrated. Therefore, these devices must be placed at one end of the Bus. For the other CAN modules (Dimmer, Relay, IO, IO small, DALI, Radio Base Modul), a resistor must be installed externally between the CAN+ and CAN- terminals if they are located at the other end of the Bus.

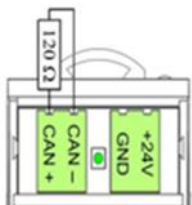

The correct termination can be checked with an ohmmeter in a voltage-free state. Simply measure the resistance between the CAN+ and CAN- terminals at any point on the Bus. This measurement should show approx. 60 Ohm (plus line resistance). Now you have to make sure that there is a server at one end of the Bus and that the 120 Ohm resistor is connected at the other end of the Bus. If the measurement only shows approx. 120 Ohm, then the termination is missing at one end.

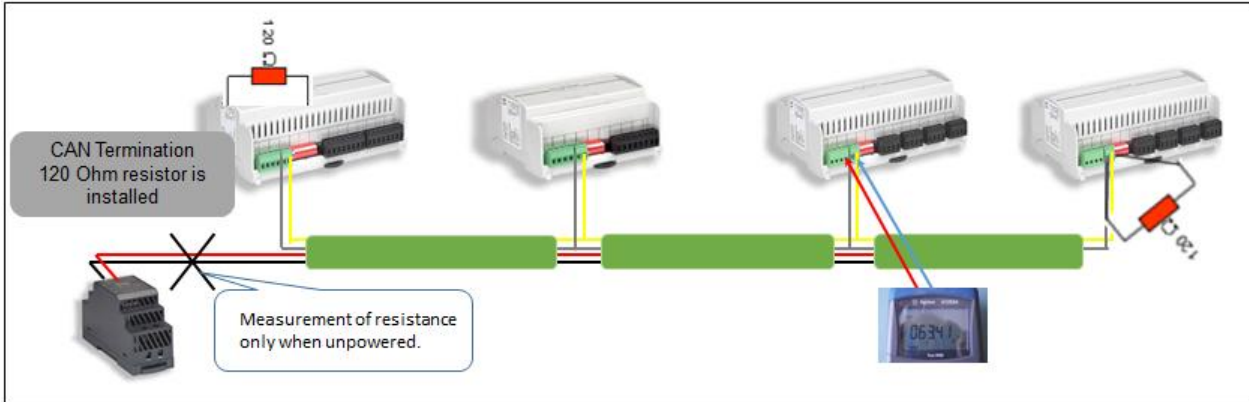

**f) Shield connection to potential earth (PE)**

The shields of the individual cable segments may be interconnected. The shield is then placed over a large area (use cable glamps) to the control cabinet ground.

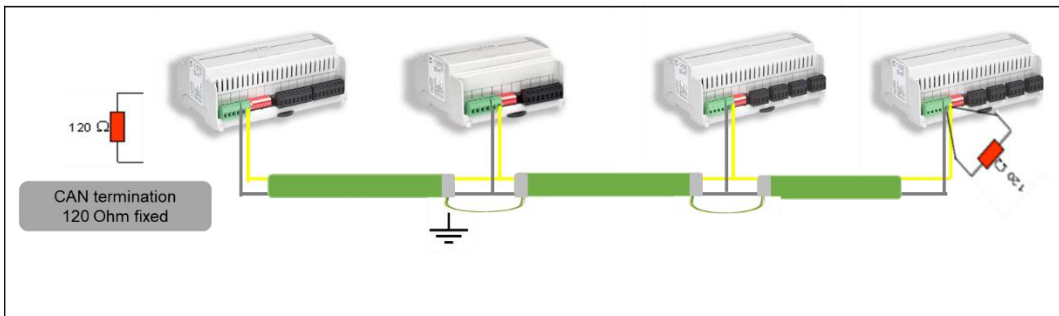

If the bus cable runs between several switch panels that are more than 3m apart, there must be no connection of the different switch panel grounds (potential balance). The connecting cable segment may then only be laid on one side (in a control panel) on control panel ground.

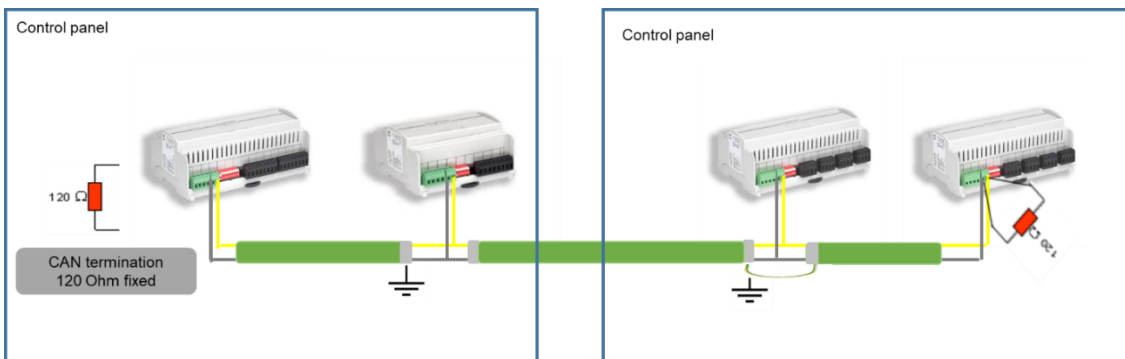

**g) Function control in 250kB-CAN network**

Each unit in the myTEM CAN network has an LED that indicates the communication status.

Smart Server MTSER-100	LED green	Device is started and ready
	LED green flashing	Device is in manual position
	LED red	Signals a device defect
	LED red flashing	During the start-up of the device, the LED flashes
	LED Off	No supply voltage
IO Modul MTIOM-100	LED green	Device is started and ready



IO Modul Small MTIOS-100 Relais Modul MTREL-100 Dimmer Modul MTDIM-100		
	LED green flashing	Device is in manual position
	LED red	Device started but has no connection to the server
	LED Off	No supply voltage
Radio Base Modul MTBAS-100-WL Dali Modul MTDAL-100	LED green	Device is started and connected to the server
	LED red	Device started but has no connection to the server
	LED Off	No supply voltage

The myTEM ProgTool offers further options for function control

## 6.2 Free Topology network

### a) Bus cable

We recommend a YCYM type cable (2x2x0.8mm). This cable type is also used in KNX installations.

### b) Transmission speed

On this Bus, data is only transmitted with 10kBit/s.

### c) Maximum cable length

The total cable length of the bus cable at a star point outlet of a FT Base Modul may be up to 500m. Longer cable stubs are also permitted here.



**Rule of thumb:** 250m bus cable (YCYM 2x2x0.8mm) at 30W consumer power.

### d) Maximum number of participants

Up to 50 flush-mounted FT modules may be connected to one star point outlet of an FT Base Modul.

### e) Topology

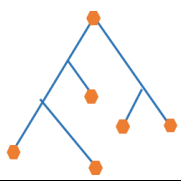
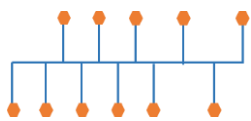
Wiring is possible in a free tree topology. Cable strands lead from an outlet of an FT Base Modul to the individual rooms of a floor. The free topology offers great flexibility in wiring!

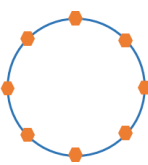
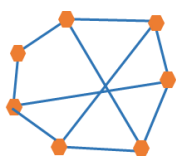
				
✓	✓	✓	✗	✗
Tree	Bus	Star	Ring	Fully meshed

### f) Termination

Because of the low transmission speed, no termination is necessary.

### g) Shield connection to potential earth (PE)

The shield does not have to be connected and grounded.

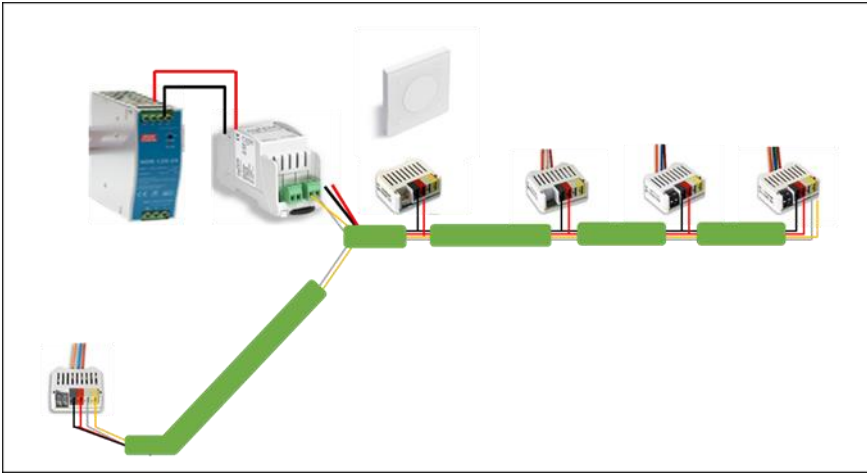

In a noisy environment (e.g. if the Bus cable runs parallel to motors with frequency converted control), the shield can be a protection against electromagnetic interference.

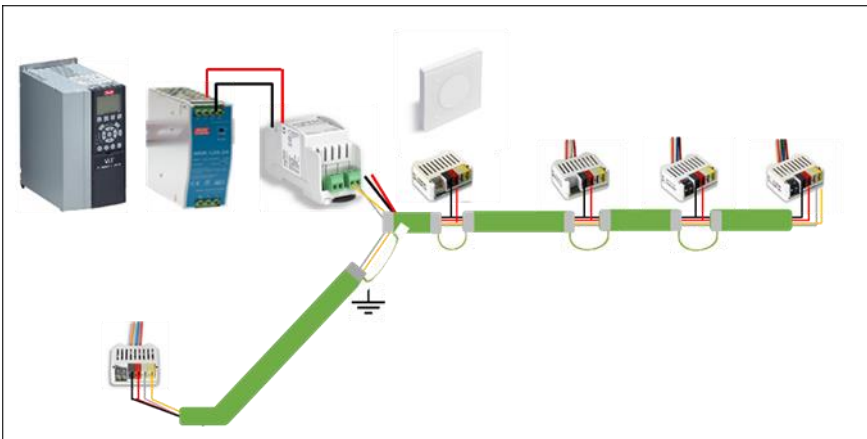

In this case, the shields may be interconnected and connected to earth potential at a central point.

#### h) Function control in the Free Topology network

Each FT module has a status LED to signal the current communication status.

FT Base Modul MTBAS-100-FT	LED green	Device started and connection to Smart Server or Radio Server OK
	LED red	Device started, but no connection to the server
	LED Off	No supply voltage
FT DIN SIX MTDIN-100-FT FT RGBW Modul MTRGB-100-FT FT Switch Dual MTSWI-100-FT FT Switch Dimmer MTSWD-100-FT	LED green flashes	Device is connected to the FT Base Modul and in normal operation
	LED green	Device receives network configurations from FT Base Modul
	LED blu flashes	Device is identified via the myTEM ProgTool



	LED green and red flashes	Device started and connected to FT Base, but not yet added to a server (ProgTool)
	LED red	Device started, but no connection to the server
	LED Off	No supply voltage

The myTEM ProgTool offers further possibilities for function control.

## 7 Device specific wiring notes

### 7.1 FT DIN SIX wiring notes

The diagram shows a terminal block with pins labeled AI1, AI2, DI1, DI2, DI3, DI4, L, and V+. Wires connect these pins to a device. A separate section shows a 'Touch Add-on (optional)' unit with pins for GND, 24 V, CFT-, CFT+, and +3 -0 +A. Wires connect these to the main device's terminal block.

Connect the AWG22 strand cables either directly at the push buttons or the switches or use connecting terminals.

To monitor Digital Inputs (DI1...DI4), they are connected to the red wire (24V / V+). When analogue Inputs (A1, A2) are used in digital mode, the red wire also connects to the switch that is monitored. When analogue inputs are used to read 0..10VDC signals or temperature sensors, they connect to the black wire (L / GND).

**Optional:** You can use the flat cable to connect the myTEM Touch Add-On room control unit Glossy

### 7.2 FT RGBW Modul wiring notes

The diagram shows a terminal block with pins for GND, 24 V, CFT-, and CFT+. Wires connect these to the device. On the right, there are four channels for LED lighting labeled W (White), B (Blue), G (Green), and R (Red). Each channel has a '+' and '-' terminal. A legend indicates 'Loads' for each channel.

A separate power supply unit is used to operate the myTEM FT RGBW Modul and the connected LED lighting. GND of this power supply must be connected to GND of the FT Base Modul. This connection is essential for reliable communication.

The myTEM FT RGBW Modul and the LED lighting should be placed as close to each other as possible. The cross-section and the cable length of the LED supply should be dimensioned in such a way that the voltage drop is a maximum of 1V. LED feeds with 1.5 mm<sup>2</sup> cables should therefore not exceed 5 m in length in order to be able to utilise the maximum control power.

Maximum current loads must not exceed 2 A per channel.

### 7.3 FT Switch Dimmer wiring notes

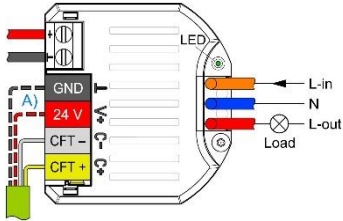
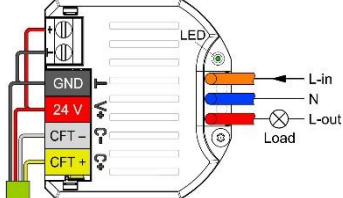
	<p>The FT Switch Dimmer uses a dimmable, electronic MOSFET output which allows to measure current flow and energy consumption of the connected loads.</p> <p>Maximum loads must not exceed 6 A, 250 VAC, (<math>\cos(\varphi) = 1.0</math>).</p> <p><b>NOTE!</b> Supply power is always connected to the screw terminals of the switch Dimmer. The red and dark grey push-in terminals may be used as distribution terminals since they are not connected to the electronic of the FT Switch Dimmer. See <b>A)</b> in the drawing.</p>
	<p>Supply power (24VDC) is always connected to the screw terminals of the switch Dimmer.</p> <p>When the wires are kept very short and do not cause a voltage drop, the device may be powered by use of solid wires (0.8mm diameter) as shown in the drawing on the left side.</p>

### 7.4 7.4 FT Switch Dual wiring notes

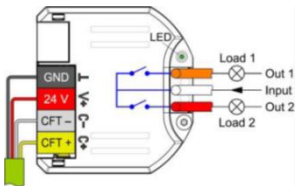
	<p>The electrical installation must be protected with a maximum overcurrent protection of 10 A.</p> <p><b>WARNING!</b> The myTEM FT Switch Dual should be installed in a box (wall, ceiling) compliant with relevant national safety standards and with a depth of not less than 60 mm. The length of the cables between the unit and the load should not exceed 10 m.</p> <p><b>NOTE!</b> Maximum loads must not exceed 6 A, 250 VAC, (<math>\cos(\varphi) = 1.0</math>).</p>
---	--

### 7.5 FT Base Modul wiring notes

	<p>Ground (GND) of the supply power may only connect to building Ground (Potential Earth, PE) of a building in one point. A common Ground is important for a reliable communication of the busses.</p> <p><b>NOTE!</b> At FT Base Modules ground of the supply voltage is connected to the dark grey push-in terminal.</p> <p>Up to 4 FT Base Modules may be connected to the same Smart Server or Radio Server via the CAN Bus. This function might be helpful, when independent networks on different floors or flats have to be built up with a central server.</p>
---	--

### 7.6 Smart Server wiring notes

	<p><b>WARNING!</b> Different voltages (e.g. 24 VDC, 230 VAC L1 or 230 VAC L2) may only be connected to the digital outputs (relays) if one output each remains FREE in between.</p> <p><b>WARNING!</b> The maximum current across all relays must not exceed 48 A.</p> <p><b>NOTE!</b> Before starting, set all DIP switches OFF, i.e. up. This prevents, for example, OPEN / CLOSE commands from being set at</p>
--	--



the same time. To check the digital outputs (relays), press DIP switch 10 down to ON. You can now switch the relays DO1 – DO8 on and off with the DIP switches 1 - 8.

To check the analogue outputs, set DIP-switches 9 and 10 to the ON position. This activates the test function. With DIP switches 1 - 4 in the ON position, you can set the analogue outputs AO1 - AO4 from 0 VDC to 10 VDC.

## 7.7 IO Modul wiring notes



**WARNING!** Different voltages (e.g. 24 VDC, 230 VAC L1 or 230 VAC L2) may only be connected to the digital outputs (relays) if one output each remains FREE in between.

**WARNING!** The maximum current across all relays must not exceed 48 A.

**NOTE!** Before starting, set all DIP switches OFF, i.e. up. This prevents, for example, OPEN / CLOSE commands from being set at the same time. To check the digital outputs (relays), press DIP switch 10 down to ON. You can now switch the relays DO1 - DO8 on and off with the DIP switches 1 - 8.

To check the analogue outputs, press DIP switches 9 and 10 down to ON.

With DIP switches 1 - 4 in the ON position, you can set the analogue outputs AO1 - AO4 from 0 VDC to 10 VDC.

## 7.8 IO Modul Small wiring notes



**WARNING!** Different voltages (e.g. 24 VDC, 230 VAC L1 or 230 VAC L2) may only be connected to the digital outputs (relays) if one output each remains FREE in between.

**NOTE!** Before starting, set all DIP switches OFF, i.e. up. This prevents, for example, OPEN / CLOSE commands are set at the same time.

To check the digital outputs (relays), press DIP switch 6 down to ON. You can now switch the relays DO1 - DO4 on and off with the DIP switches 1 - 4.

To check the analogue outputs, press DIP switches 5 and 6 down to ON. With DIP switches 1 and 2 in the ON position, you can set the analogue outputs AO1 and AO2 from 0 VDC to 10 VDC.

## 7.9 Relais Modul wiring notes

**WARNING!** The maximum current across all relays must not exceed 48 A.

**NOTE!** Before starting, set all DIP switches OFF, i.e. up. This prevents, for example, OPEN / CLOSE commands from being set at the same time. To check the digital outputs (relays), press DIP switch



12 down to ON. You can now switch the relays DO1 - DO11 on and off with the DIP switches 1 - 11.

## 7.10 Dimmer Modul wiring notes



Do not connect any luminaires with integrated dimmers. The unit may be damaged.

Do not connect LED or compact fluorescent lamps that are not expressly suitable for dimming. The unit may be damaged.

When operating with inductive transformers, fuse them on the primary side according to the manufacturer's instructions. Only use safety transformers according to IEC/EN 61558-2-6.

**WARNING!** The unit is not suitable for disconnection, i.e. it does not provide disconnection or interruption. Even when the unit is switched off, the load is not galvanically isolated from the mains.

**NOTE!** Before starting, set all DIP switches OFF, i.e. up. In this way, you avoid that, for example, OPEN / CLOSE commands are set at the same time.

To check the outputs, press DIP switch 6 down to ON. You can now use switches 1 - 4 to set the analogue outputs AO1 - AO4 from 0 % to 100 %.

## 7.11 DALI Modul wiring notes



**NOTE!** The DALI Bus requires an external DALI power supply to work properly. Such a DALI power supply needs to meet the DALI specifications. Use only one power supply per line (max. 64 DALI devices).

Standard house wiring cable NYM (1,5mm<sup>2</sup>) may be used for the DALI Bus. A free topology (line, star, tree) is allowed for a DALI network. Do not create rings or meshed networks. The DALI Bus cable may run alongside with 230VAC lines. The voltage drop between our DALI Module and the most remote DALI device may not exceed 2V. The maximum DALI Bus length is 300m.

## 7.12 Radio Base Modul wiring notes



Up to 4 myTEM Radio Base Modules with the same myTEM Smart Server can be used on the CAN Bus. This can be useful for example when flats are to have their own independent Z-Wave networks with a central server.

When mounted in a control cabinet, the external antenna myTEM MTANT-100-WL should be used

### 7.13 Radio RGBW Modul wiring notes



**NOTE!** The RGBW Modul must be supplied by the same power supply as the LED-strips connected to the RGBW Modul.

**NOTE!** The maximum total length of LED strips may not exceed 10m. Longer strips may cause a higher voltage drop which may decrease the brightness of the lights. Therefore it is better to install short LED strips in parallel instead of in series.

When mounted in a control cabinet, the external antenna myTEM MTANT-100-WL should be used

### 7.14 Radio IO Modul wiring notes



**WARNING!** Different voltages (e.g. 24 VDC, 230 VAC L1 or 230 VAC L2) may only be connected to the digital outputs (relays) if one output each remains FREE in between.

**NOTE!** Before starting, set all DIP switches OFF, i.e. up. This prevents, for example, OPEN / CLOSE commands are set at the same time.

To check the digital outputs (relays), press DIP switch 8 down to ON. You can now switch the relays DO1 – DO6 on and off with the DIP switches 1 - 6.

When mounted in a control cabinet, the external antenna myTEM MTANT-100-WL should be used

### 7.15 Radio IO Modul Floor wiring notes



**WARNING!** Different voltages (e.g. 24 VDC, 230 VAC L1 or 230 VAC L2) may only be connected to the digital outputs (relays) if one output each remains FREE in between.

**NOTE!** The silently switching SSR relays can handle a maximum current of only 0,05A. Thus we advise to switch 230VAC in order to achieve a high performance.

## 7.16 Radio Switch Dual wiring notes

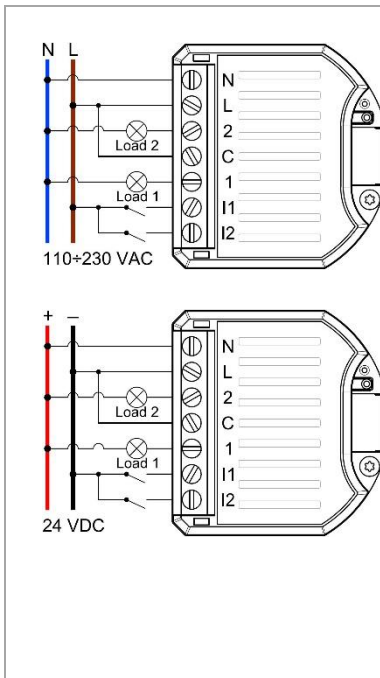

The electrical installation must be protected with a maximum overcurrent protection of 10 A.

**WARNING!** Do not mix different voltages. Thus your installation should either be done in 24 VDC or 110- 230 VAC.

**WARNING!** The Radio Switch Dual shall be mounted in a flush box (wall or ceiling) according to national standards. We advice to use boxes of at least 60mm depth. Connecting cables to switches or loads may not exceed 10m.

**NOTE!** For 110-230VAC installations: monitored switches are connected to mains (see the upper drawing on the left side).

For 24VDC installations: monitored switches are connected to GND (see the lower drawing on the left side).

**NOTE!** The maximale load may not exceed **6 A, 250 VAC, (cos(φ) = 1.0)**

Place the antenna upright and as far away as possible from metal parts and cables for optimum range. Attention: Do not shorten the antenna!

## 7.17 Radio Switch Dual Plus wiring notes

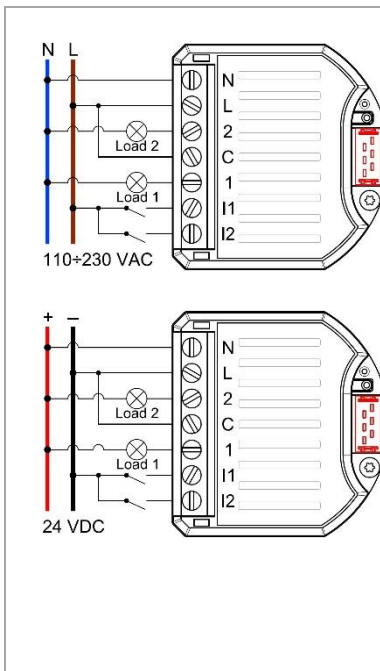

The electrical installation must be protected with a maximum overcurrent protection of 10 A.

**WARNING!** Do not mix different voltages. Thus your installation should either be done in 24 VDC or 110- 230 VAC.

**WARNING!** The Radio Switch Dual shall be mounted in a flush box (wall or ceiling) according to national standards. We advice to use boxes of at least 60mm depth. Connecting cables to switches or loads may not exceed 10m.

**NOTE!** For 110-230VAC installations: monitored switches are connected to mains (see the upper drawing on the left side).

For 24VDC installations: monitored switches are connected to GND (see the lower drawing on the left side).

**NOTE!** The maximale load may not exceed **6 A, 250 VAC, (cos(φ) = 1.0)**

Place the antenna upright and as far away as possible from metal parts and cables for optimum range. Attention: Do not shorten the antenna!

Optional: Use a flat cable to connect a myTEM Touch Add-On room control.



## 7.18 Radio Switch Shutter Plus wiring notes

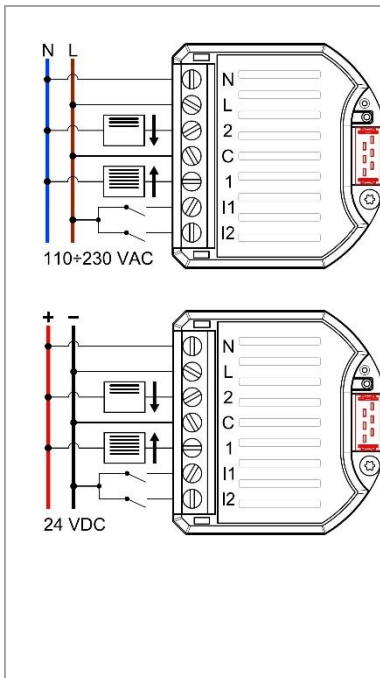

The electrical installation must be protected with a maximum overcurrent protection of 10 A.

**WARNING!** Do not mix different voltages. Thus your installation should either be done in 24 VDC or 110- 230 VAC.

**WARNING!** The Radio Switch Dual shall be mounted in a flush box (wall or ceiling) according to national standards. We advice to use boxes of at least 60mm depth. Connecting cables to switches or loads may not exceed 10m.

**NOTE!** For 110-230VAC installations: monitored switches are connected to mains (see the upper drawing on the left side).

For 24VDC installations: monitored switches are connected to GND (see the lower drawing on the left side).

**NOTE!** The maximale load may not exceed **6 A, 250 VAC, (cos(φ) = 1.0)**

Place the antenna upright and as far away as possible from metal parts and cables for optimum range. Attention: Do not shorten the antenna!

Optional: Use a flat cable to connect a myTEM Touch Add-On room control.

## 7.19 Radio Switch Dimmer wiring notes

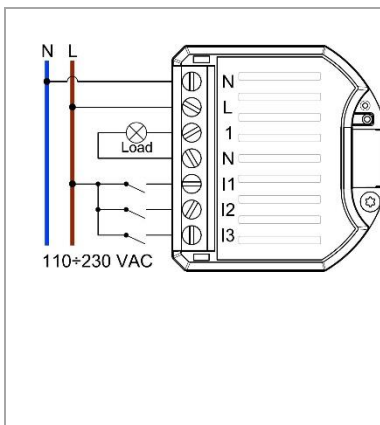

The electrical installation must be protected with a maximum overcurrent protection of 10 A.

**WARNING!** The Radio Switch Dual shall be mounted in a flush box (wall or ceiling) according to national standards. We advice to use boxes of at least 60mm depth. Connecting cables to switches or loads may not exceed 10m.

**NOTE!** Monitored switches are connected to mains (see the drawing on the left side).

Place the antenna upright and as far away as possible from metal parts and cables for optimum range. Attention: Do not shorten the antenna!

## 8 Z-Wave Wireless network

### 8.1 Installation

#### a) How I do set up and operate a Z-Wave based Radio network

A Z-Wave network always consists of a control station and at least one and max. 231 other devices. The control station organises the network and controls other devices in the network. These devices can also control each other. Control stations (primary controllers) in the myTEM network are a Radio sever or a Radio Base Modul in cooperation with a Smart Server. Primary controllers assign the home ID to other Z-Wave devices in the network. The other Radio modules (Wireles/ WL) do not have the capability to assign home ID's. Our range of sensors **[S]** (Door contacts, temperature) and actuators **[A]** (switches, dimmers, thermostats, sockets) can be supplemented by Z-Wave devices from other manufactures.

In such cases, we recommend that our support department be consulted before using the equipment.

#### b) Positions of the devices

Z-Wave devices have a robust Radio connection and can use other Z-Wave devices operated (which are constantly connected to supply power) as routers. If the direct Radio connection is disturbed, they forward radio signals from other devices. This means that there are hardly any restrictions on installation. However, the following instructions must be observed:

- Avoid metal surface closer than 30 cm to the device.
- More units in permanent operation (24V or 230V-powered) make the network more reliable in terms of radio technology thanks to the routing function.
- Do not wrap or shorten antennas!
- 24V or 230V powered actuators and sensors are always active (hence router), while sensors with batteries (door-window sensor / motion detector / water sensor / thermostat) are only active when they are "woke up". In addition, they activate regularly - for example every 15 minutes - to request new commands from the control centre. Actuators with batteries such as door locks or sirens are also always active, but consume more power.

#### c) Tips for planning a Z-Wave network

- Before you start to include all actuators and sensors into the Z-Wave network, you should take time for a well thought-out planning.
- Make a layout or drawing of the floor plan.
- Subdivide into permanently powered (router, mesh capable) and battery-powered devices.
- Arrange permanently supplied devices so that they are evenly distributed throughout the entire flat. As a guideline, it is recommended that each room has a current-carrying actuator or sensor.
- The primary controller is ideally placed centrally. This enables a homogeneous distribution of the Z-Wave signal around the gateway.
- Start to include those devices first that are placed close to the primary controller (Base). Start with the permanently powered devices, which then build up a meshed network. Include the battery-operated components in a next step, starting with the devices close to the base.

### 8.2 Network connection

To set up a radio network, it is necessary that all devices have a common identification (home ID). Within a network, each device must have a unique device address (device ID). The common home ID is assigned by the primary controller (myTEM Server or myTEM Radio Server). Assigning the home ID adds or includes a controller to the network. In order to operate a Z-Wave device in another network or on another primary controller, it must first be removed (excluded) from the existing network.

Please observe the corresponding procedures for all Z-Wave devices. These procedures are described in detail in the operating instructions.



## 9 Lightning and overvoltage protection

If lightning protection is required, the wiring of the active wires must be carried out according to DIN VDE 0185 Part 1 or draft DIN VDE 0185 Part I 00 with lightning current arrester (primary protection). In the case of cross-building cable routing, lightning current arrester must be installed in the Bus cable at the building entrance or the Bus cable protected with surge arresters must be routed in a metal duct or metal pipe included in the equipotential bonding on both sides.

### 9.1 Earthing and potential compensation

The shielding of the Bus cable must be connected over a large area to the control panel earth (shielding terminal, cable strap, cable glamp) or to the next protective conductor terminal. The following shielding options are permitted:

- Connect all shields with each other and connect them to PE in a large area at a central point.
- Connect each bus segment to PE at one point. The shields of the individual bus segments must not be connected to each other.

Both variants ensure that the shields of the Bus cables are not included in the equipotential bonding.

### 9.2 Avoid overvoltages

Loops are often the cause of EMC interference due to overvoltages caused by flashes of lightning. Such loops must therefore be avoided as far as possible. Loops are also caused by two independent mains connected to one unit. Induced surge voltages lead to breakdowns in the connected devices, whereby destruction can be caused.

The following rules must be observed:

- Bus and power cables must always be installed physically separated from each other as far as possible.
- Cable ends should be as far away as possible from earthed parts and from other cable ends.
- Sufficient distance must be kept from the external flash protection system (for example, from lightning arrestors).

## 10 Contact

Working with us creates unique advantages for you. Benefit from our many years of experience. Talk to us!

TEM AG  
Triststrasse 8  
CH-7007 Chur

Phone: +41 81 254 25 25

Email: [info@mytem-smarthome.com](mailto:info@mytem-smarthome.com)

Link myTEM Smart Home: <https://www.mytem-smarthome.com/web/en>

Link myTEM Smart Home FAQ: <https://www.mytem-smarthome.com/web/en/faq/>

Link myTEM Smart Home Downloads: <https://www.mytem-smarthome.com/web/en/downloads/>

Link myTEM Smart Home Partner Login: <https://www.mytem-smarthome.com/web/en/shop/>